



# Wyndham Boat Launching Facility

Planning & Concept Design Report

20 June 2017

Level 4, 600 Murray St  
West Perth WA 6005  
Australia

301320-14638-MA-REP-0001

[www.advisian.com](http://www.advisian.com)



**Advisian**

WorleyParsons Group



**Disclaimer**

This report has been prepared on behalf of and for the exclusive use of Shire of Wyndham East Kimberley, and is subject to and issued in accordance with the agreement between Shire of Wyndham East Kimberley and Advisian.

Advisian accepts no liability or responsibility whatsoever for it in respect of any use of or reliance upon this report by any third party.

Copying this report without the permission of Shire of Wyndham East Kimberley and Advisian is not permitted.

**Project No: 301320-14638-MA-REP-0001 – Wyndham Boat Launching Facility: Planning & Concept Design Report**

<b>Rev</b>	<b>Description</b>	<b>Author</b>	<b>Review</b>	<b>Advisian Approval</b>	<b>Date</b>
A	Issued for Internal Review	CSM C Meisl	ADB A Blanksby		
B	Issued for Client Review	CSM C Meisl	ADB A Blanksby	ADB A Blanksby	26-May-17
C	Re-Issued for Client Review	<i>C Meisl</i> C Meisl	<i>ADB</i> A Blanksby	<i>ADB</i> A Blanksby	20-Jun-17



# Table of Contents

Executive Summary.....	vi
1 Introduction .....	1
1.1 Background .....	1
1.2 Scope of Work.....	1
1.2.1 Maritime Engineering .....	1
1.2.2 Aboriginal Heritage Survey .....	1
1.2.3 Survey.....	2
2 Customer Supplied Data .....	2
2.1 Introduction.....	2
3 Existing Facility .....	4
4 Stakeholder Consultations – Existing Facility.....	6
4.1 Introduction.....	6
4.2 Fact Finding / Lessons Learned Meetings.....	6
4.3 Questionnaire – Public Feedback on Existing Facility and Concept Options .....	7
5 Basis of Design and Coastal Desktop Study.....	9
6 Concept Layout Options.....	9
6.1 Concept Layout Options.....	9
6.2 Landside Layout – Trailer Parking and Turning Areas .....	9
6.3 Option 1: Floating Pontoon Option .....	12
6.4 Option 2: Fixed Sloping Low Level Jetty Option.....	16
6.5 Alternative Location .....	18
6.5.1 Option 4: Alternative Location – Revetment Option .....	19
6.5.2 Option 4: Alternative Location – Sheet Pile Wall Option.....	21



6.5.3	Alternative Options at Existing Location .....	22
6.6	Repair and Maintain Existing Pontoon.....	23
7	Stakeholder Consultations – Concept Options .....	23
7.1	Introduction.....	23
7.2	SWEK Stakeholder Advisory Group Meeting .....	23
7.3	Questionnaire – Public Feedback on Concept Options .....	24
8	Capital Cost Estimate.....	25
8.1	Purpose and Objective.....	25
8.2	Basis of Estimate.....	25
8.2.1	Summary of Estimate.....	25
8.2.2	Estimate Classification and Accuracy.....	26
8.2.3	Estimate Structure.....	26
8.2.4	Key Qualifications and Assumptions .....	26
8.2.5	Owners and Engineering Design Costs.....	27
8.2.6	Contingency .....	27
8.2.7	Exclusions .....	27
9	Multi-Criteria Analysis .....	28
10	Recommended Concept Option.....	33



**Advisian**

WorleyParsons Group

**Shire of Wyndham East Kimberley**  
**Wyndham Boat Launching Facility**  
Planning & Concept Design Report



## Appendix List

- Appendix A Stakeholder Consultations – Existing Facility
- Appendix B Basis of Design
- Appendix C Coastal Desktop Study
- Appendix D Concept Design Options
- Appendix E Stakeholder Consultations – Concept Options
- Appendix F ± 40% CAPEX Estimate



## Executive Summary

---

The Shire of Wyndham East Kimberley (SWEK) obtained funding through the Department of Transport's Round 21 Recreational Boating Facilities Scheme (RBFS) program and municipal funds to conduct planning and concept design studies for the redevelopment of the Wyndham Boat Launching Facility. This study included maritime engineering, topographic and hydrographic survey, and a desktop Aboriginal heritage review.

The existing Wyndham Boat Launching Facility is located in the Cambridge Gulf in Wyndham. The Wyndham Boat Launching Facility provides the only access for recreational boat users to the Cambridge Gulf area. This area experiences annual flooding, extremes in tidal movement ranging in excess of 8 m and tidal currents, which can exceed 3 knots.

The existing boat launching facility is at the end of its service life, and facility users have raised concerns with its usage and function.

Stakeholders were engaged early in the study to obtain feedback on the existing facility and what they would like to see included in the concept design options. Engagement was carried out by onsite meetings in Wyndham and Kununurra and through a questionnaire published on SWEK's website.

The following concept design options were developed in conjunction with upgrades to the landside trailer parking area:

- Option 1: Floating pontoon option
- Option 2: Fixed sloping jetty option
- Sheltered boat ramp located at an alternative site considering:
  - Option 3: Sloped revetments
  - Option 4: Sheet pile side walls

A +/- 40% CAPEX cost estimate was completed for the upgrades to the landside trailer parking area and for the floating pontoon and fixed sloping jetty option. The estimated cost for both the floating pontoon and fixed jetty option were similar. The total estimated CAPEX including the landside is \$3,300,000 excluding GST, for the floating pontoon option. This includes a 25% contingency, design and project management costs.

All four options were presented to stakeholders for comment and to rank their preferred option. This consultation was conducted through a questionnaire published on SWEK's website. The respondents preferred Option 1, the floating pontoon.

Based on responses received from stakeholders and a multi-criteria analysis conducted, the floating pontoon option is recommended.



# 1 Introduction

---

## 1.1 Background

The Shire of Wyndham East Kimberley (SWEK) obtained funding through the Department of Transport's Round 21 Recreational Boating Facilities Scheme (RBFS) program and municipal funds to conduct planning and concept design studies for the redevelopment of the Wyndham Boat Launching Facility.

The existing Wyndham Boat Launching Facility is located in the Cambridge Gulf in Wyndham. The Wyndham Boat Launching Facility provides the only access for recreational boat users to the Cambridge Gulf area. This area experiences annual flooding, extremes in tidal movement ranging in excess of 8 m and tidal currents, which can exceed 3 knots (Wallingford 1971, refer to Section 2.1).

The existing boat launching facility is at the end of its service life, and facility users have raised concerns with its usage and function.

## 1.2 Scope of Work

SWEK has engaged consultants to assist in completing the planning and concept design of the Wyndham Boat Launching Facility redevelopment, covering engineering design, aboriginal heritage and survey.

### 1.2.1 Maritime Engineering

Advisian has been engaged by SWEK to complete maritime engineering aspects including:

- Site inspection at Wyndham;
- Concept design report, including basis of design and concept design layout for the new facility;
- Undertake stakeholder consultation in the form of a public meeting in Kununurra or Wyndham, presenting the two concept designs;
- Order of Magnitude cost estimate for preferred concept option; and
- Coastal desktop study in order to assess the current and wave conditions at the site.

### 1.2.2 Aboriginal Heritage Survey

Preston Consulting has been engaged by SWEK to complete the aboriginal heritage aspects of the study including:

- A desktop Aboriginal heritage survey study was completed to determine the native title group and if there are any heritage sites within 50m of the boat launching facility boundary. The study concluded that there is low risk to Aboriginal heritage for re-development of the boat



ramp in its current location. The results of the desktop study are contained in “Desk Top Study Assessment for Aboriginal Heritage at the Wyndham Boat Launching Facility for the Shire of Wyndham East Kimberley, February 2017” prepared by Preston Consulting and Horizon Heritage Management.

### 1.2.3 Survey

MNG was engaged by SWEK to complete a feature survey of the site area.

## 2 Customer Supplied Data

### 2.1 Introduction

Table 2-1 details the information that has been provided by SWEK or obtained through public sources.

**Table 2-1 Background Information and Reports**

Document No	Title	Remarks
<b>Wyndham Boat Ramp</b>		
01015-02233-MA-RP-0001 - 110411	Wyndham Boat Ramp Floating Jetty Options for Maintenance and Replacement, April 2011, WorleyParsons	Boat ramp site inspection
<b>Geotechnical Information</b>		
	Pile Driving ITPs from Anthon’s Landing, Maritime Construction	Pile driving records from Anthon’s Landing, constructed 2011
	Anthon Landing Jetty – Seismic Refraction Survey, December 2010, Marine & Earth Sciences	Single 2D seismic refraction survey along Anthon Landing Jetty
	FQA – PDA Testing, Anthon Landing, Maritime Construction	PDA testing of piles
	Field Investigation Report – Wyndham Port – Container Terminal Pavement	Geotechnical investigation (onshore) near at Port.
2942W	Report on Site Investigation for L.A.S.H Terminal Project at Wyndham, April	Geotechnical investigations (offshore) at Anthon’s





Document No	Title	Remarks
	1971, Halpern, Glick & Lewis Pty Ltd	Landing
<b>Anthon Landing Jetty Constructed by Maritime Constructions and Aztec Analysis</b>		
AAD100461-A05-RevB	Anthon Landing Jetty, Jetty Long Section	Anthon landing design drawings
AAD100461-A17-RevB	Anthon Landing Jetty, Pile Set-out Plan	Anthon landing design drawings
AAD100461-A18-RevB	Anthon Landing Jetty, Pile Set-out Coordinates	Anthon landing design drawings
	Anthon Landing Jetty, Design Report & Maintenance Plan, Dec 2011, Maritime Constructions and Aztec Analysis	Anthon Landing Jetty, Design Report & Maintenance Plan
301015-02233-MA-RP-001 Rev B	Anthon Landing Jetty, Management Plan, Dec 2011	Anthon Landing Jetty, Management Plan
<b>Coastal Data</b>		
DOR 696-80-01	Wyndham Submergence Curve, April 2010, DOT	
DOI 10.1006/ecss.2001.0799	Rapid, Human-Induced Siltation of the Macro-Tidal Ord River Estuary, Western Australia, Wolanski et al, Estuarine, Coastal and Shelf Science (2001) 53, 717-732	Current Measurements at Spring tides near Wyndham Port
EX 586	Port of Wyndham, Siltation Study, Sept 1971, HR Walingford	
<b>Other Documents</b>		
	Anthon's Landing Landscape Report & Concept, August 2012, Blackwell & Associates Pty Ltd.	Landscape concept report for area surrounding boat ramp and Anthon's landing
	Proposed Community Jetty, Anthon's Landing, Environmental Impact Assessment, March 2010, Nicole Siemon and Associates PL	EIA for Anthon landing jetty

### 3 Existing Facility

The existing boat launching facility is located at the Wyndham Foreshore, and just to the south of the existing Anthon's Landing Jetty, as shown in Figure 3-1.



**Figure 3-1 Location Plan**

The existing boat ramp facility comprises of a two-lane boat ramp with a floating access pontoon as shown in the photos in Figure 3-2. The facility was constructed in the 1970s and extended in the 1990s. An existing barge loading ramp is located to the south of the southern boat ramp. The existing facility is nearing the end of its useful life and will either require replacement or increased ongoing maintenance, (refer to document number 01015-02233-MA-RP-0001 – 110411).



SWEK does not have any "as-constructed" drawings or technical information on the existing facility.



**Figure 3-2 Photos of the Existing Wyndham Boat Launching Facility**



## 4 Stakeholder Consultations – Existing Facility

### 4.1 Introduction

Prior to the development of boat ramp concept design options, stakeholders were consulted in order to understand issues experienced with the current facility and attributes they would like to see included in the concept design options. Stakeholders were consulted via the following means:

- Fact finding / lessons learned meeting with existing facility users in Wyndham and Kununurra.
- Online questionnaire asking users experience with existing facility and potential improvements.

Further details are provided in the sections below.

### 4.2 Fact Finding / Lessons Learned Meetings

Chris Meisl (Advisian - Senior Marine Structural Engineer) and Mark Davidson (SWEK – Manager Engineering Services) attended two stakeholder meetings to discuss:

- How the existing boat launching facility is used;
- Environmental conditions; and
- Issues with existing facility and upgrades that should be considered in the concept options.

The meetings were held on 27 and 28 of February 2017 in Wyndham and Kununurra respectively. Refer to Appendix A for minutes from the meetings. Key points raised by stakeholders are as follows, and shown in Figure 4-1:

- Concerns regarding the condition of the existing ramp and pontoon, and funds available to perform ongoing maintenance of the facility.
- Local environmental conditions:
  - Large tidal range (8.7m). In king tides Foreshore Road will flood.
  - Currents of up to 6kn (3m/s).
  - Lots of debris (trees, etc.) come down the river and form a raft on the pontoon.
  - Estuarine crocodiles present on site.
- Use of existing facility:
  - All users use 4x4 vehicles to tow vessels. Typical vessel is 6m long, longest vessel is approximately 10m long.
  - Existing layout has enough room to manoeuvre vehicles and trailers on/off ramp.
  - Tidal currents can be very strong. Boats are launched and retrieved on the leeward side of the current. Once launched / prior to retrieval, usually tie up to the pontoon with a single line off the bow and let vessel swing in current
  - When currents are strong, and vessel in on the wrong side of pontoon, they can be pushed/pinned against the structure.



- Issues with the existing facility:
  - The existing pontoon was installed approximately 20 years ago, and is in poor condition.
  - Pontoon is very 'lively' in storms.
  - The piles are located outside of the pontoon and make berthing difficult to larger vessels.
  - North ramp cannot be used at low tides due to 'L' pontoon being too close. This can be a safety issues if currents wrong direction and South ramp needs to be used.
  - The existing North boat ramp is constructed using Flex Mats. Some of the concrete units (at approximately MSL) have come off and are a tripping hazard.
  - South ramp is generally in good condition and serviceable.
  - The existing flood light does not provide adequate lighting levels.
  - The existing trailer parking bay has been constructed on reclaimed land and has some soft spots that tend to be avoided by cars.
- Upgrades to consider in concepts:
  - Upgrades to lighting.
  - Allow access to barge landing ramp to the south of the ramp.
  - Extend pontoon and shift 'L' pontoon further seaward.
  - Provide additional bollards and fenders for mooring.
  - Upgrade pavement / gravel surface of the parking areas.
  - Consider additional amenities; compostable toilet, fish cleaning station and rubbish bins, a boat cleaning bay.
  - Consider foreshore landscaping upgrade study in concept design.

### **4.3 Questionnaire – Public Feedback on Existing Facility and Concept Options**

SWEK published a questionnaire requesting feedback on the existing facility on the Shire's website. The purpose of the questionnaire was to assess what types of vessels and trailers use the facility, issues experienced using the ramps and pontoon, and proposed features users would like considered in the concept designs. A total of 6 responses were received. Regarding the existing facility, the responses in general are similar to those obtained during the fact finding / lessons learned meetings, refer to Section 4.2. The questionnaire and summary of responses can be found in Appendix A.



**Figure 4-1 Issues with Existing Boat Launching Facility**



## 5 Basis of Design and Coastal Desktop Study

---

A Basis of Design (BoD) has been developed for the Wyndham Boat Launching Facility and is contained in Appendix B. This BoD is to be reviewed and amended as required for subsequent design phases.

A Coastal Desktop Study has been completed to assess local wave and current conditions and is contained in Appendix C.

## 6 Concept Layout Options

---

### 6.1 Concept Layout Options

The following concept designs have been developed for the Boat Launching Facility:

- Landside – trailer parking and turning areas
- Floating pontoon option
- Fixed jetty option
- Inland option – revetment side walls
- Inland option – sheet pile wall side walls

These options are discussed in the following sections. Concept drawings can be found in Appendix D.

A multi-criteria analysis comparing the various options can be found in Section 9.

### 6.2 Landside Layout – Trailer Parking and Turning Areas

Concept drawings of the landside layout are shown in Drawing No's 301320-14638-MA-SKT-1000 to 1001, and shown in Figure 6-1 and Figure 6-2.

A summary of the key aspects of the landside concept design are as follows:

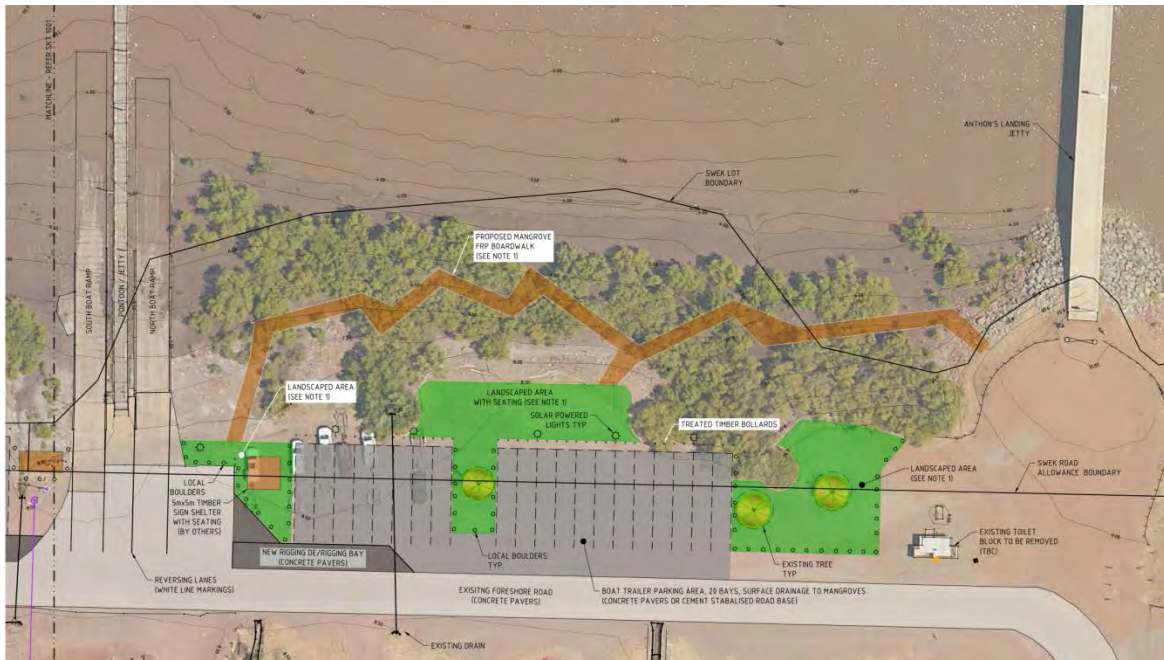
- Rigging / de-rigging bays added to the north and south side of entrance to ramp. While allowing for a temporary parking bay for users to prepare the vessels, it will also help the reduction in excessive wear on the adjacent gravel pavements during turning manoeuvres. It is proposed that these rigging / de-rigging bays to be brick pavers, similar to the existing Foreshore Road.
- The concept layout has an allowance for 40 trailer parking bays in total; 20 to the north and 20 to the south of the ramp. A parking exclusion zone is located in front of the existing barge landing ramp. Depending on barge loading operations, additional parking bay may be required to be temporarily blocked off.
- The proposed parking bays pavement can be either brick pavers or crushed gravel / recycled concrete fill. The existing subgrade has been reclaimed, and details on how this reclamation



was constructed are not known. To construct the entire area of brick pavers will be costly, and could require replacing the existing subgrade if found inadequate. DoT guidelines mention that 50% of parking should be paved. This is a guideline and it could be argued that this is not required for this facility due to site levels, amount of usage, etc. The parking areas could be progressively upgraded to brick pavers in the future as funds become available.

- Due to existing site levels, the entire parking area will be submerged during King Tide events.
- The trailer parking area is proposed to drain to the mangroves, as is the current situation.
- Turning manoeuvres using the design vehicle and trailer have been performed to check that there is adequate space at the top of the ramp to launch/retrieve a vessel and enter a parking bay. Figure 6-3 shows the worst case turning circles.
- The existing drainage network located under Foreshore Road would be maintained and extended/upgraded as required.
- A compostable toilet is proposed near the ramp. The existing toilet block near Anthon's Landing may either be removed or refurbished.
- Solar powered lights are proposed in the parking area.
- A 5mx5m shelter for signage and seating, to be provided by Others.
- Indicative landscaping, seating areas, shelters and mangrove boardwalk are indicated to address the Shire's long term landscaping plan for the area (refer to Section 12.2). These improvements would be completed as a separate project by Others.
- The Shire would need to acquire additional Crown land to the south of the ramp to cater for additional trailer parking area.

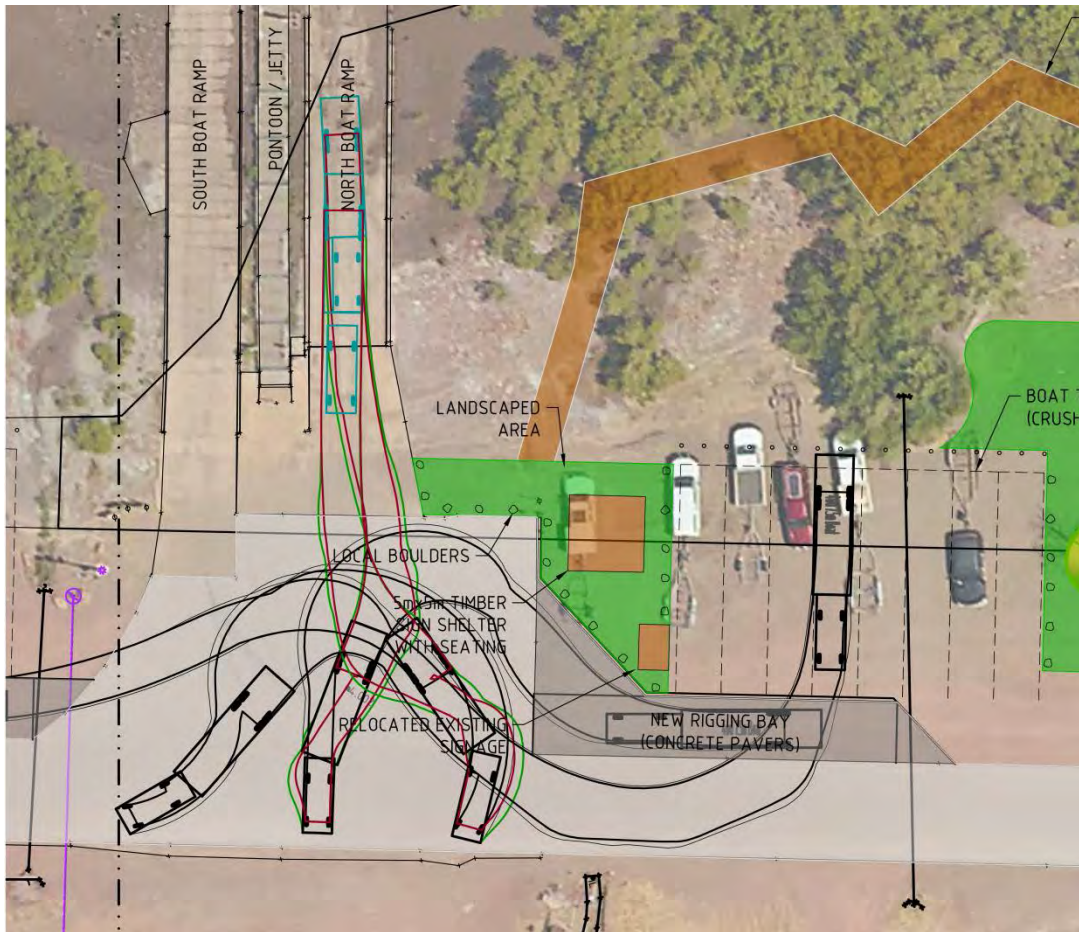




**Figure 6-1 Landside Layout North of Ramp (Refer to Drawing No 301320-14638-MA-SKT-1000)**



**Figure 6-2 Landside Layout South of Ramp (Refer to Drawing No 301320-14638-MA-SKT-1001)**



**Figure 6-3 Turning Manoeuvres for 4-Wheel Drive Vehicle with Trailer**

### **6.3 Option 1: Floating Pontoon Option**

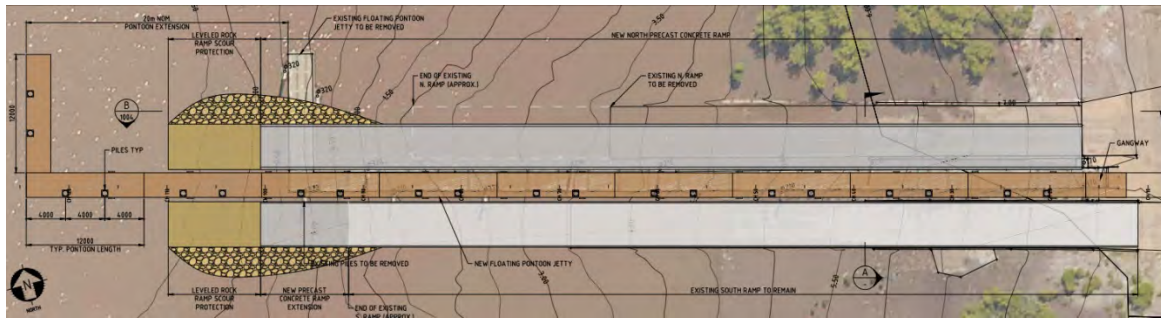
Concept drawings of the floating pontoon concept option are shown in Drawings No 301320-14638-MA-SKT-1003 – 1004, and shown in Figure 6-4 to Figure 6-6. A summary of the key aspects of the floating pontoon option concept design are as follows:

- Boat launching ramps:
  - The existing ramp grade is approximately 1 vertical (V) to 10-14 horizontal (H). Due to the existing site levels, steepening the ramps would require excavation/dredging and increased sedimentation of the ramp could potentially be expected. The existing ramp grades are proposed to remain.
  - South ramp is to remain. Based on the site inspection and user feedback, the ramp is usable and serviceable.
  - North ramp is to be removed and replace with new precast concrete ramp. The ramp location is proposed to be shifted south from its current position in order to limit the gap

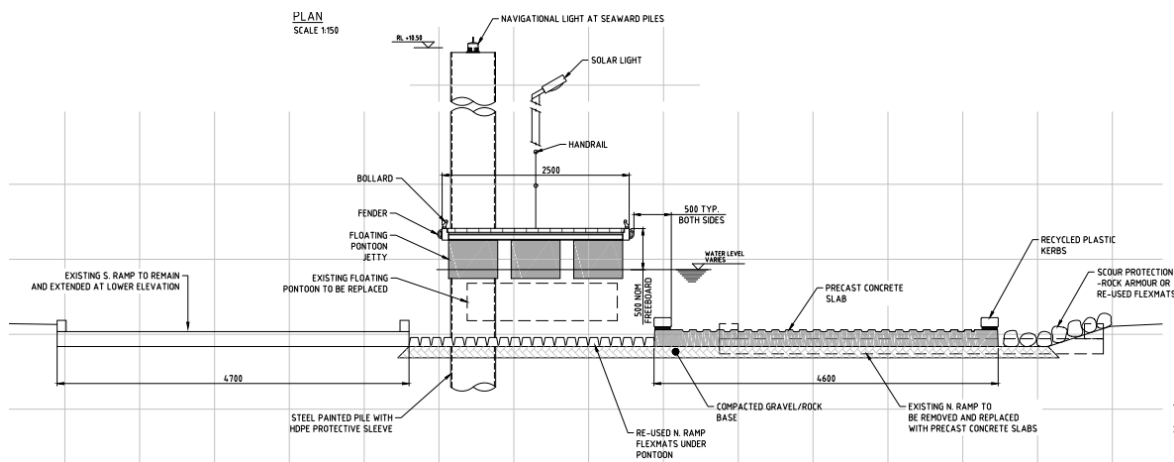


between the jetty and ramps. The existing North ramp subgrade is to remain and be used for the new precast concrete ramp.

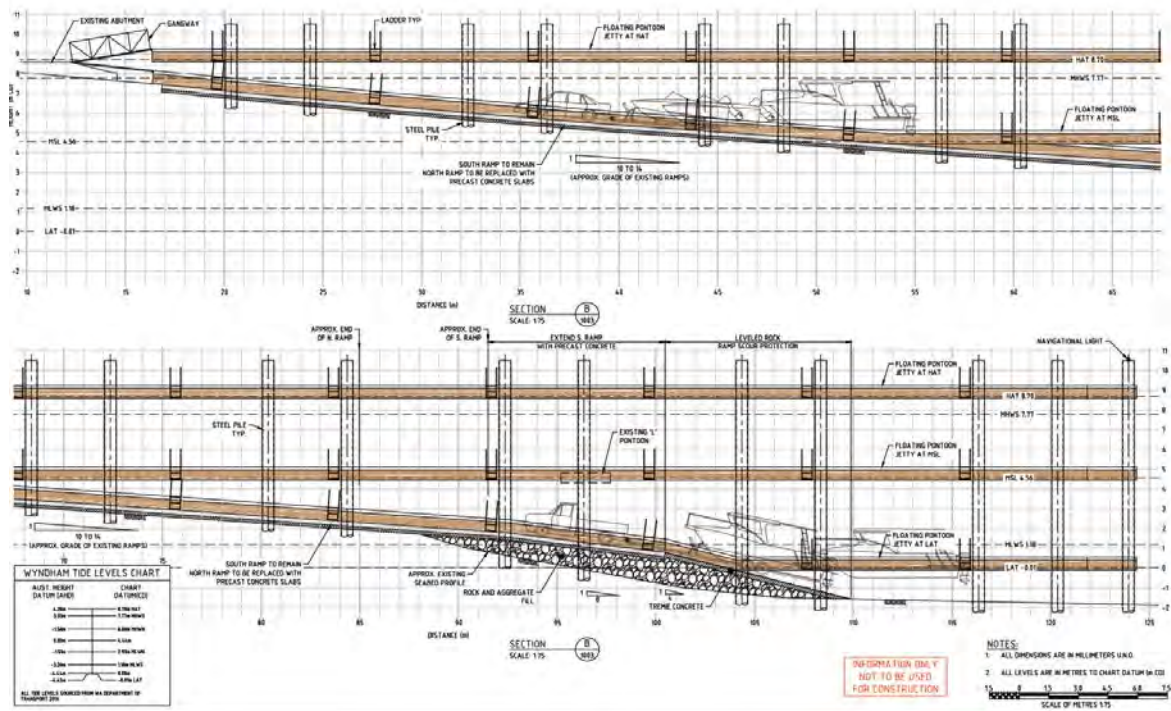
- Both North and South ramps to be extended further to allow for use at lower tides. The extension is based on a combination of precast concrete units and rock/gravel subgrade with tremie concrete. The final 15-20m of extended ramp is proposed to be steepened to 1V:8H and 1V:4H to minimise the extended length of the ramp and subgrade required. The ramp is proposed to be extended to allow for vessel launch and retrieval at LAT.
- Floating pontoon:
  - The floating pontoon would be extended by approximately 20m such that 'L' pontoon is no longer a restriction on using the North ramp at low tides.
  - The pontoon structure would be restrained by piles. The piles would be located inboard of pontoon so as to not interfere with vessel berthing. The piles could have an HDPE sleeve for corrosion protection.
  - The existing Flex Mat forming the North ramp would be re-used and relocated under the pontoon units to provide a level bedding surface for the pontoons at lower tides and provide scour protection to the adjacent ramps.
  - The proposed pontoon is approximately 2.5m wide.
  - Handrails would be provided down the centre of the pontoon.
  - Solar power lights would be provided on the pontoon.
  - In general the pontoon would function similar to the existing pontoon. Issues due to debris and movement during extreme wave events would still be present. The deck structure and piles would be upgraded to minimise some of the damage that is being currently being observed on the existing pontoon (e.g. pile guide failures).
  - Options for supplying the pontoon structure include:
    - Using a proprietary pontoon system. Examples include Poralu (Engineered Water Systems) and Walcon Marine, refer to Figure 6-7. These pontoon systems typically consist of aluminium pontoon frames, polyethylene and foam filled floats, decking and miscellaneous fixtures (fenders, bollards, etc). The warranty period for these various components varies, but is typically between 10-15 years. Spare parts are generally readily available. Due to the environment at the proposed location (waves, strong currents, debris, etc), the standard design of the pontoon framing and piles may need to be strengthened. Warranties will also need further discussion / negotiation with the preferred supplier.
    - The pontoons may be specifically engineered to suit the local conditions. The pontoons could be constructed using aluminium, steel or concrete floats with structural framing.
    - Re-using the existing pontoon structure, refer to Section 6.6.



**Figure 6-4 Plan – Floating Pontoon Option**



**Figure 6-5 Typical Section – Floating Pontoon Option**



**Figure 6-6 Elevation – Floating Pontoon Option**



**Figure 6-7 Typical Proprietary Floating Pontoon (Ref. Walcon Marine)**

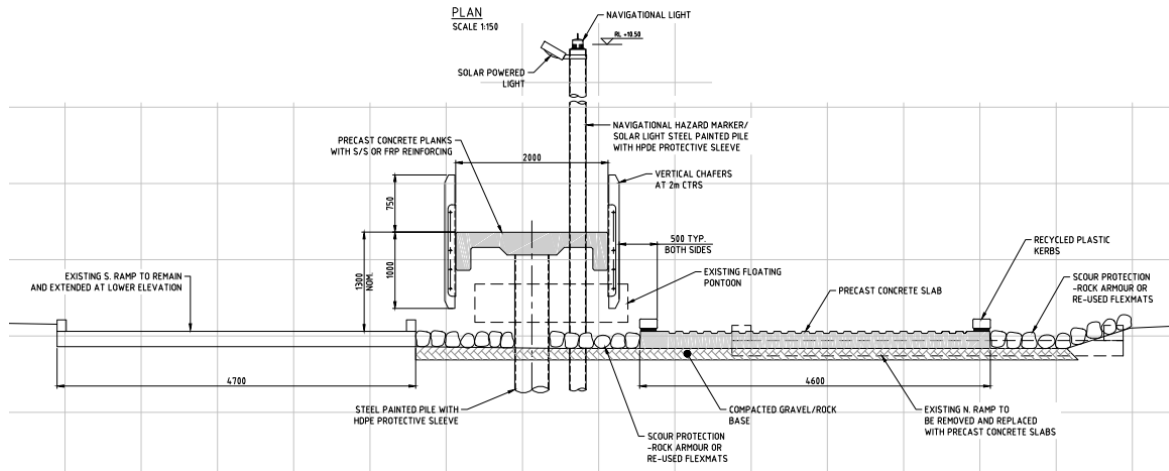


## 6.4 Option 2: Fixed Sloping Low Level Jetty Option

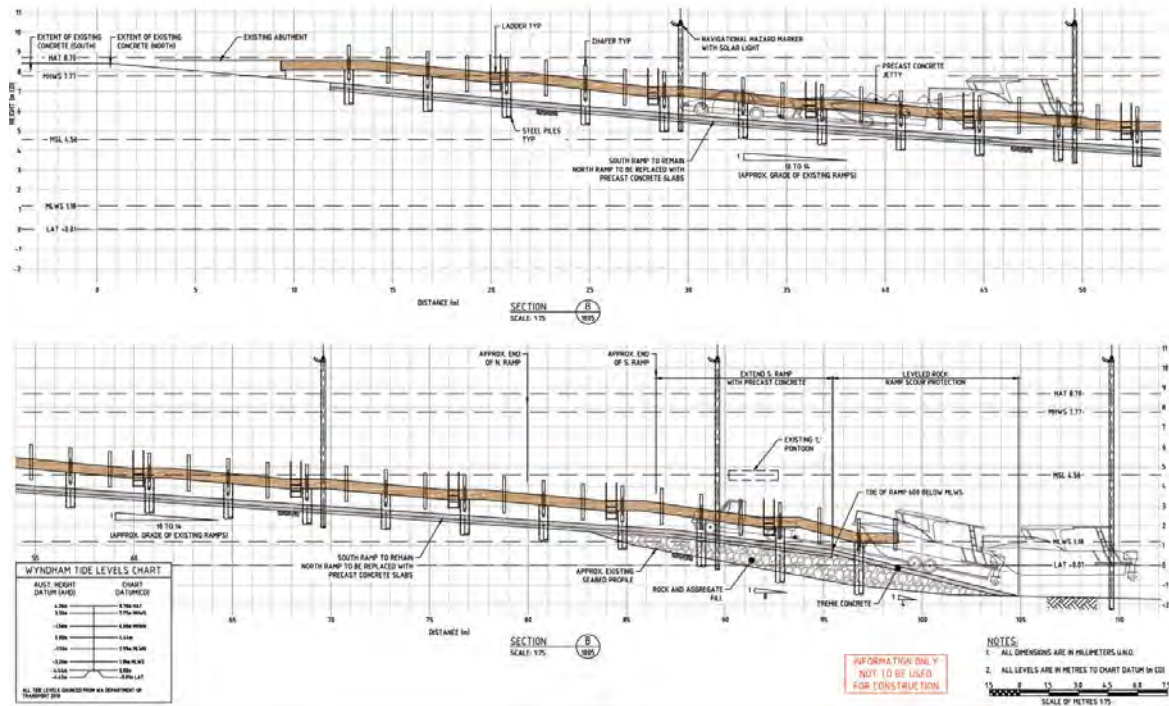
Concept drawings of the fixed sloping low level jetty concept option are shown in Drawing No's 301320-14638-MA-SKT-1005 to 1006, and shown in Figure 6-9 to Figure 6-11. A summary of the key aspects of the fixed sloping low level jetty concept design are as follows:

- Fixed sloping low level jetties have been used in other WA boat ramp locations where there are large tidal ranges, e.g. Dampier Public Boat Ramp, refer to Figure 6-8.
- Boat launching ramps:
  - The proposed boat launching ramp concept is similar to the floating pontoon option. Refer to Section 6.3 for further details.
- Fixed Jetty:
  - The top of the fixed jetty is approximately 1.3m above the ramp level. The jetty slopes to approximately match the slope of the adjacent ramps, horizontal/flat sections of jetty are spaced at regular intervals to break-up the slope.
  - The concept option considers the jetty to extend to the MLWS tide level. At LAT vessels would not be able to access the jetty. However water levels lower than MLWS are only experienced < 3% of the year (refer to Appendix B).
  - Only a portion of the jetty could be used at a time due to the tides.
  - An 'L' to 'T' head at the end of the jetty would not be possible as it would be submerged at higher tides. Consideration could be given to installing additional mooring piles at the end of the jetty for boats to tie onto temporarily.
  - The fixed jetty structural concept includes precast concrete deck units supported on steel tubular piles. In order to increase the durability of the concrete, the reinforcement should be either FRP or stainless steel. Other structural concepts such as steel, aluminium or FRP framing may also be considered.
  - The fixed jetty option would gather less debris compared to a pontoon system as portions of jetty will be below water depending on tide (i.e. for approximately 50% of the time, 50% of the jetty will be below water, with debris floating over top of the jetty). Some debris may still get caught under the structure, and would require removal.
  - As the structure is fixed, it would not be susceptible to wave induced movements compared to a floating pontoon system.
  - This option is considered to be more robust than a floating pontoon system.
  - Navigational aids / hazard markers would be required as part of the structure is submerged. These would consist of vertical piles extending approx. 1.5-2m above HAT. The top of the navigational markers would include navigational lights and/or solar power lighting.
  - Lighting to the ramp would be provided by providing solar power lights on the top of the navigational piles. Due to the large tidal range the lighting levels at the water surface may either be too illuminated or not illuminated enough. Access for maintenance would also be difficult as the lights would be located above HAT.





**Figure 6-10 Typical Section – Fixed Jetty Option**





A potential solution to meet the intended requirements of the Marina Code is to relocate the ramp to a sheltered location. This can be achieved by shifting the ramp inland either to the south or north of the existing facility into the mud-flats. The ramp would be excavated into the existing ground providing a 'sheltered' environment. The side slopes can be either an armoured revetment or sheet pile wall structure (see options discussed below in Sections 6.5.1 and 6.5.2). Refer to Figure 6-12 for an example of a boat ramp located in a sheltered inland location in Port Hedland.

The end / lower elevation of the ramp would be near the top of the existing mangroves. This would provide a sheltered location for boats to launch where the effect of waves and currents would be minimised. As the new ramp is sheltered and the currents are reduced, only a single ramp would be required. On the side of the ramp a floating pontoon would be constructed. Due to the soft soils, the precast-concrete ramp would need to be placed on a thick subbase of crushed rock / aggregate. As the existing ground levels are at approximately MHWS (+7.7mCD), the access road and turning area would need to be raised to existing road levels approximately +9mCD. The access road and turning areas would require ground improvements (thick layer of subgrade material). Trailer parking could be provided to the south of the existing boat ramp facility.

The alternative locations require further engineering studies including geotechnical investigations to determine ground conditions, assessment of acid sulfate soils, and coastal studies to assess wave and current, and sedimentation, etc.



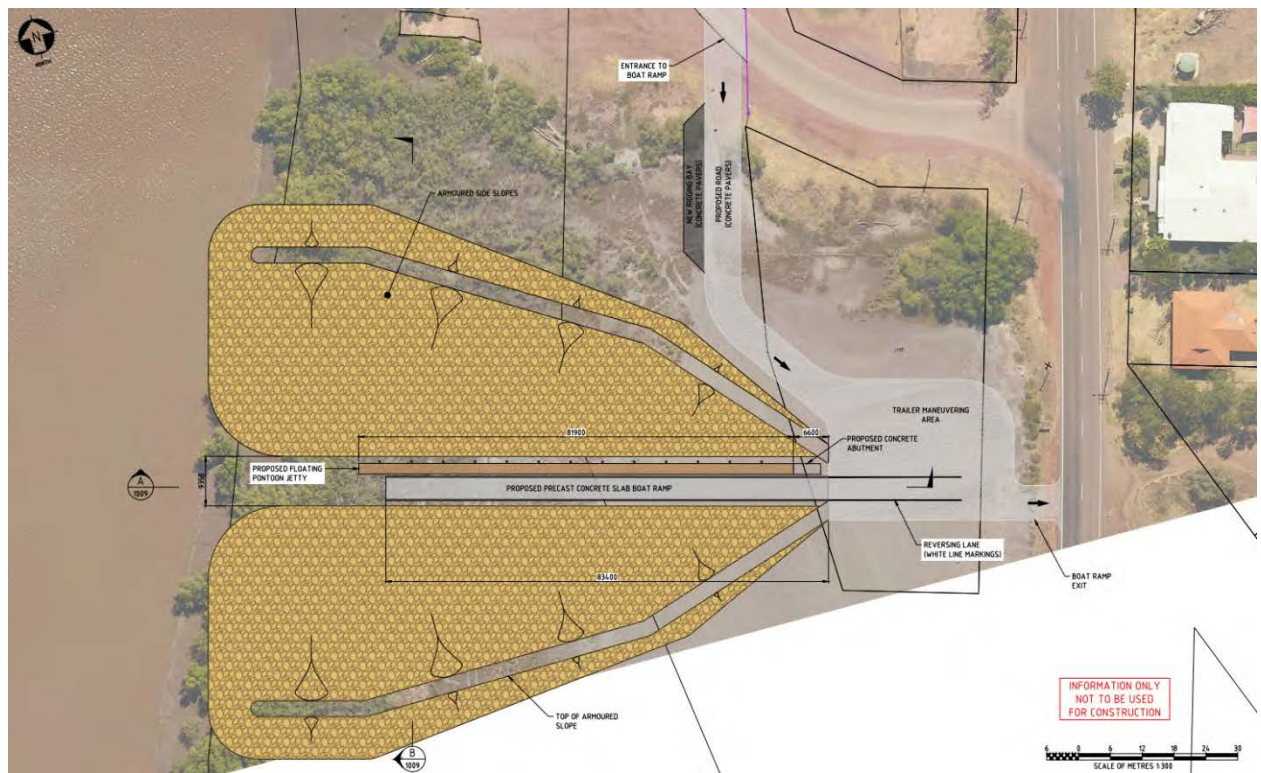
**Figure 6-12 Example of a 'sheltered' inland boat ramp located in Port Hedland.**

### **6.5.1 Option 4: Alternative Location – Revetment Option**

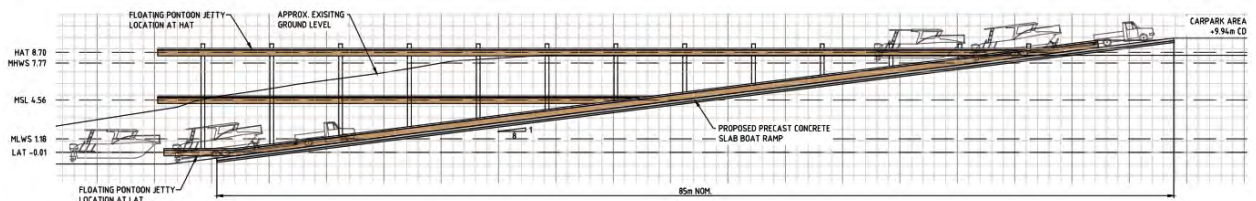
Concept drawings of the alternative location revetment side slope concept option are shown in Drawings No 301320-14638-MA-SKT-1008 – 1009, and shown in Figure 6-13 to Figure 6-15. A

summary of the key aspects of the alternative location with revetment side slope concept are as follows:

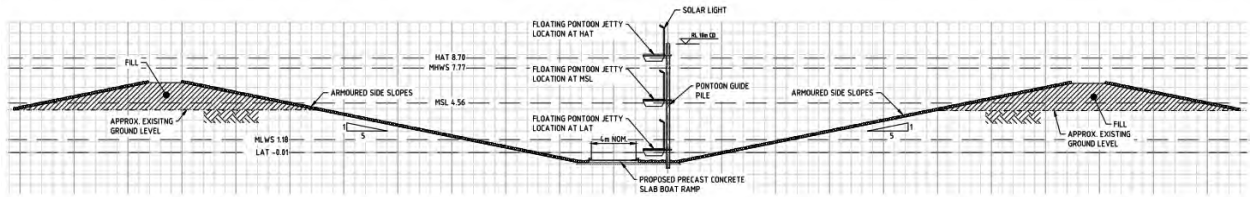
- As the proposed location of the boat ramp is located in existing mud flats, the insitu material is anticipated to be soft. Batter slopes would be required to be fairly flat, approximately 1V:5H. The side slopes protected by armour stone / Flex Mats.
- Due to the flat side slopes the overall footprint and material requiring excavation will be relatively large.
- Some siltation will probably occur at entrance. This would need to be studied further in future coastal studies. Siltation could be managed with an excavator mounted on a barge, or long reach excavator on the boat ramp working at low tides.



**Figure 6-13 Plan – Alternative Location – Revetment Side Slope Option**



**Figure 6-14 Elevation – Alternative Location – Revetment Side Slope Option**

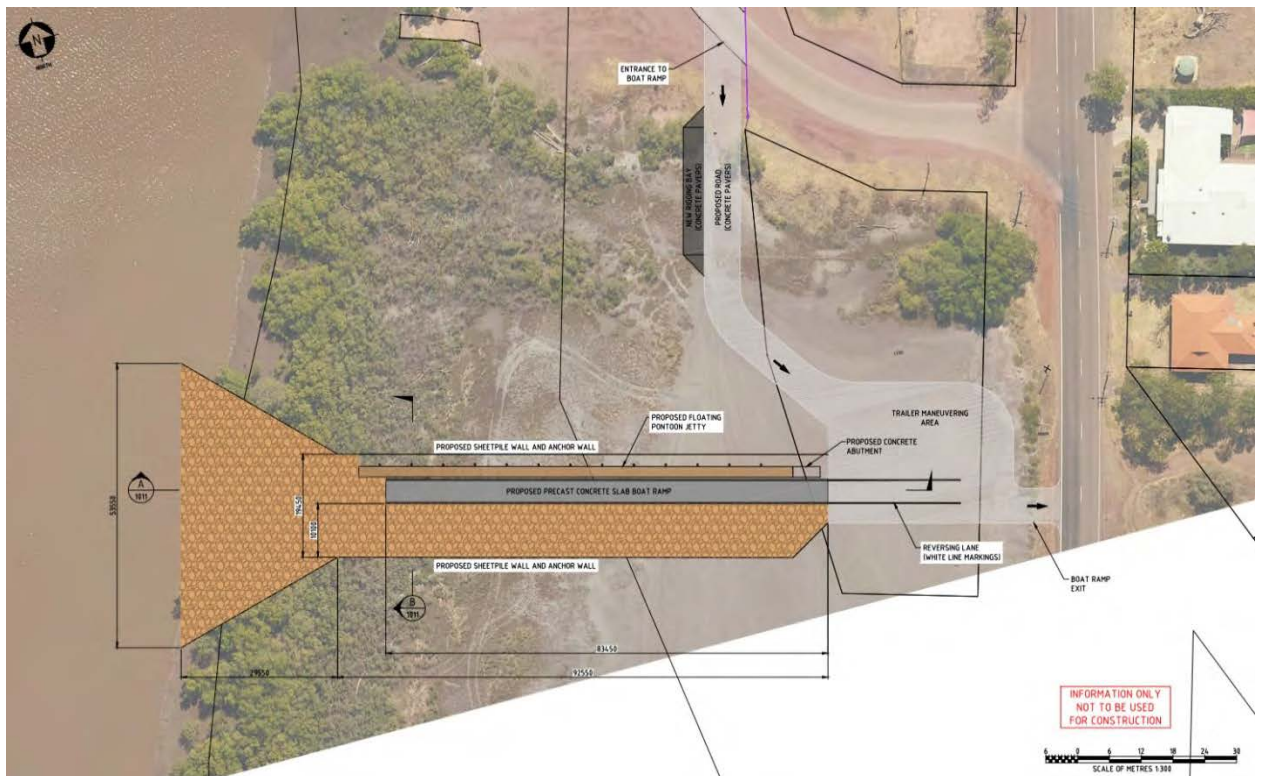


**Figure 6-15 Typical Section – Alternative Location – Revetment Side Slope Option**

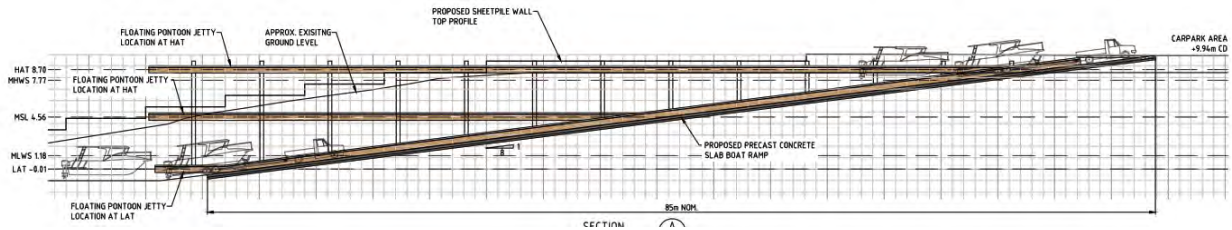
### 6.5.2 Option 4: Alternative Location – Sheet Pile Wall Option

Concept drawings of the alternative location sheet pile wall side wall concept option are shown in Drawing No's 301320-14638-MA-SKT-1010 to 1011, and shown in Figure 6-16 to Figure 6-18. A summary of the key aspects of the alternative location with sheet pile side walls concept are as follows:

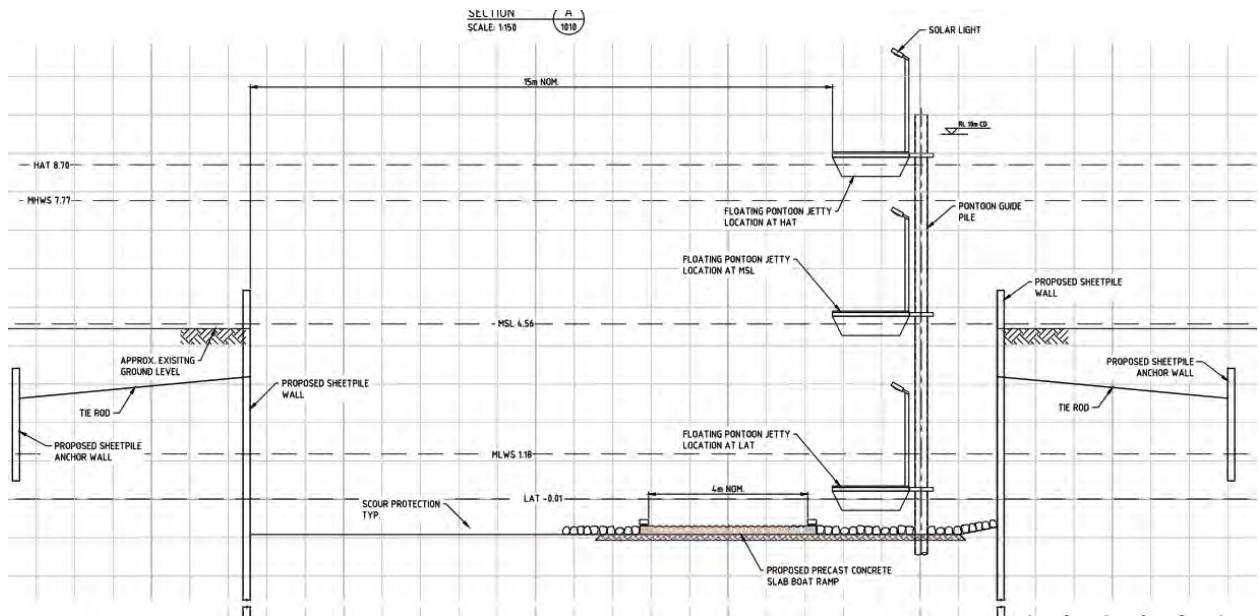
- In order to reduce the overall project footprint, sheet pile walls are proposed rather than armoured batter slopes.
- The ramp would be more sheltered then revetment option.
- Some siltation will probably occur at entrance, but to a lesser extent than the revetment option.



**Figure 6-16 Plan – Alternative Location – Sheet Pile Wall Option**



**Figure 6-17 Elevation – Alternative Location – Sheet Pile Wall Option**



**Figure 6-18 Typical Section – Alternative Location – Sheet Pile Wall Option**

### 6.5.3 Alternative Options at Existing Location

The following options to provide a sheltered location at the existing boat ramp location were considered, but not pursued further due to high CAPEX and environmental impacts:

- Installation of either a sheet pile wall or new revetments or breakwater on either side of the existing ramps. This would minimise the impact of currents and debris on the boat ramp. This would require a large foot print, impact on sediment transportation, and affect the overall look of the facility. Proposed structure would require the existing barge unloading operations to move to another location.
- Install floating breakwaters around the existing ramps. These may block debris from impacting the pontoon/jetty and attenuate the waves. Floating breakwaters would not minimise the effect of currents, would need to be supported by piles and have a large CAPEX.



## 6.6 Repair and Maintain Existing Pontoon

As an alternative to the proposed concept design options listed above, repairs and maintenance to the existing boat ramps and pontoon could be considered. The amount of repairs would vary depending on the available budget:

- Low Cost Option
  - Spot repairs to the North ramp Flex Mat.
  - Reactive and ongoing maintenance to pontoon.
  - Replace / additional bollards and fenders
- High Cost Option
  - Remove, replace and extend the North Ramp (as per concept options listed above).
  - Extend South Ramp (as per concept options listed above).
  - Remove floating pontoon and refurbish with new aluminium framing, decking, fenders and bollards. Further analysis is required to determine if the existing pontoons will be able to be brought up to Code compliance. Additional pontoon units will need to be constructed in order to extend the floating pontoon.
  - Remove and replace piles.
  - Add Flex Mats under pontoon.
  - It is anticipated that the CAPEX of the high cost option will be similar to installing a new pontoon.

## 7 Stakeholder Consultations – Concept Options

---

### 7.1 Introduction

Stakeholders were consulted in order to obtain feedback on the concept options developed and which is their preferred option. Stakeholders were consulted via the following means:

- Public consultation meeting with SWEK Stakeholder Advisory Group.
- Questionnaire seeking public feedback on facility concept designs.

Further details are provided in the sections below.

### 7.2 SWEK Stakeholder Advisory Group Meeting

Chris Meisl (Advisian - Senior Marine Structural Engineer) and Mark Davidson (SWEK – Manager Engineering Services) attended the SWEK Stakeholder Advisory Group (SAG) Meeting in Wyndham on 27 March 2017. The purpose of the meeting was to present the background to the project, issues experienced by current facility users and to present the boat ramp facility concept options.

Refer to Appendix E for minutes from the meetings. Key points raised by stakeholders were as follows:

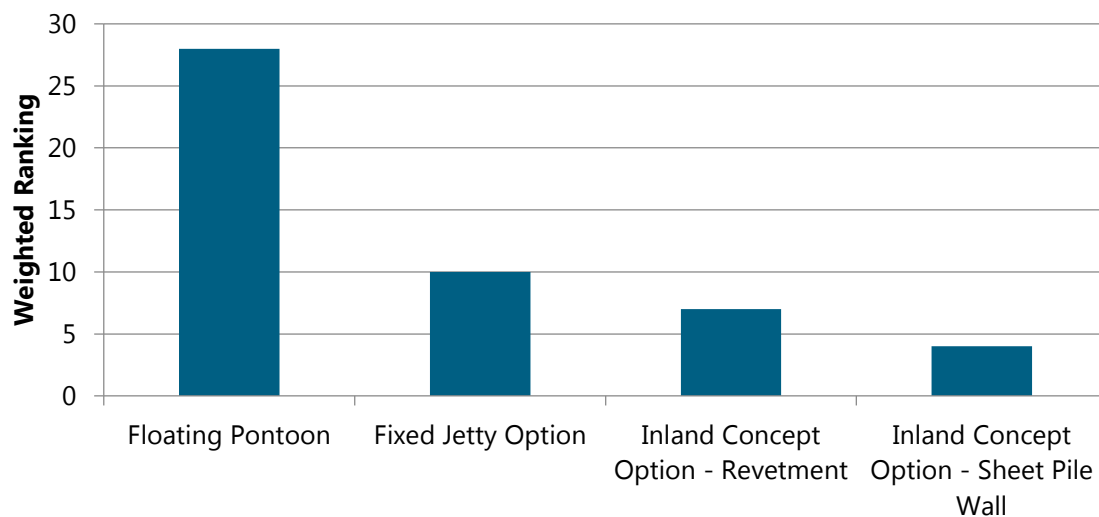
- Floating pontoon option looked upon favourably. Feedback that the existing pontoon has generally worked well and suited its purpose.
- Fixed jetty structure option had concerns regarding access, potential for vessels to collide with a submerged structure, and crocodile access to jetty.
- Inland harbour options concerns regarding costs and requirement for maintenance dredging.

### 7.3 Questionnaire – Public Feedback on Concept Options

SWEK published a questionnaire requesting feedback on the proposed concept options on the Shire’s website. The purpose of the questionnaire was for the public to rank their preferred option and provide additional feedback and improvements to the concept options. The questionnaire can be found in Appendix E.

A total of 7 responses were received. Regarding the existing facility, the responses in general are similar to those obtained during the fact finding / lessons learned meetings, refer to Section 4.2.

All respondents preferred the floating pontoon concept option located at the existing location. In order to assess the preference of the users, a weighted points system was applied. Options that were 1<sup>st</sup> preference were assessed with 4 points and 4<sup>th</sup>/ last preference given 1 point. If an option was not ranked by the Respondent, 0 points were given. The results of the weighted ranking are shown in Figure 7-1. Regarding the existing facility, the responses in general are similar to those obtained during the fact finding / lessons learned meetings, refer to Section 4.2.



**Figure 7-1 Weighted Ranking of Respondents Preferred Option**

## 8 Capital Cost Estimate

### 8.1 Purpose and Objective

The purpose of this capital cost estimate is to provide SWEK with an estimate of the installation of a replacement boat ramp at Wyndham including the landside/parking upgrades.

The cost estimate has been prepared for the following concept options, including the landside upgrades (trailer parking):

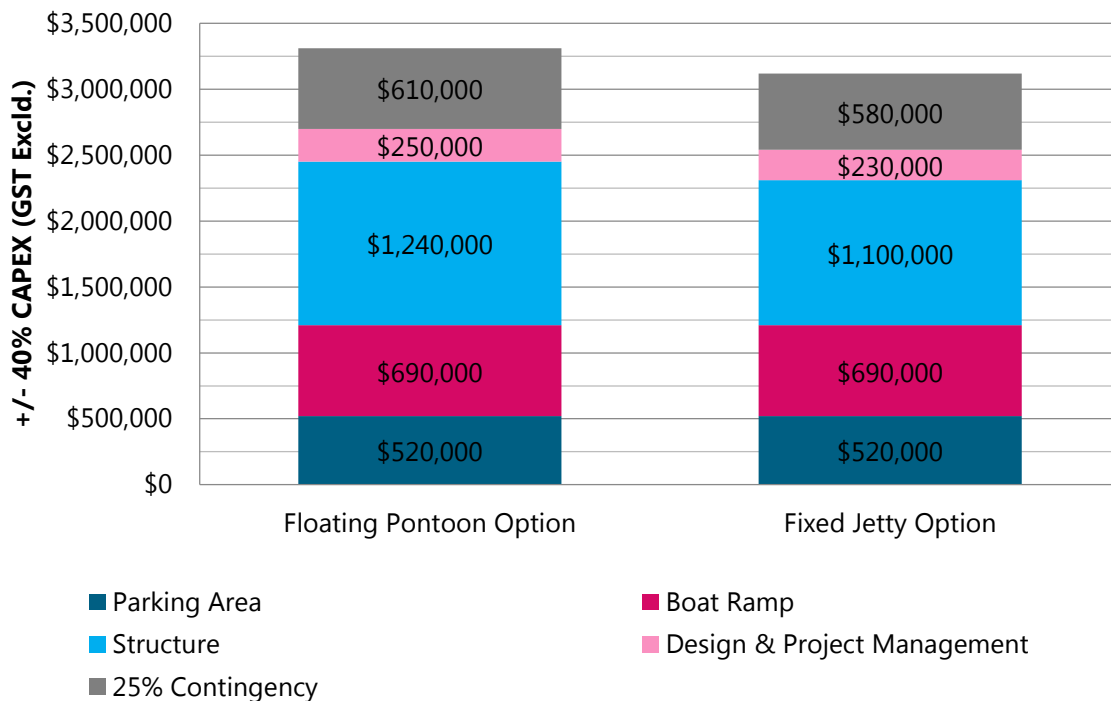
- Floating Pontoon Option 1
- Fixed Jetty Option 2

### 8.2 Basis of Estimate

#### 8.2.1 Summary of Estimate

The total estimated costs for the concept options are as follows and shown in Figure 8-1.

- Floating Pontoon Option 1: \$3,310,000
- Fixed Jetty Option 2: \$3,120,000



**Figure 8-1 +/- 40% CAPEX Estimate**



The full cost estimate can be found in Appendix F.

## **8.2.2 Estimate Classification and Accuracy**

This capital cost estimate is an Advisian Class 1 to 2 estimate with an expected target accuracy of +/-40%.

A 25% contingency has been applied to the base estimate.

## **8.2.3 Estimate Structure**

The capital cost estimate has been prepared in MS Excel 2010 and is presented in priced List of Work Items. The following estimates have been prepared:

- Landside and Trailer Parking Area – All Paved: This assumes that the entire car park area has been paved as per the concept drawings.
- Landside and Trailer Parking Area – Minimum Paved: This assumes that only the rigging/de-rigging bays have been paved and that the other areas of the car park consist of a compacted gravel surface.
- Boat Ramp: Estimate to remove and replace North boat ramp, and extend both the North and South Boat ramps. It is assumed that the boat ramp cost is the same for both concept options considered.
- Floating Pontoon Option 1.
- Fixed Sloping Jetty Option 2.

## **8.2.4 Key Qualifications and Assumptions**

The following qualifications were noted when preparing the capital cost estimate:

- Estimate base date is 2nd Quarter 2017.
- Estimate is in Australian Dollars.
- Estimate is based on a construct only contract.
- Rates based on similar marine projects and published estimating norms (Rawlinson's) using appropriate regional site adjustment factors.
- Installation of piles will be completed by barge.
- Piling installation assumes no hard rock or drilling.
- Excavation assumes no rock.
- Unsuitable excavated material can be disposed of locally.
- Works will be carried out by local contractors and therefore no allowance has been included for accommodation, flights or personnel mobilisation/demobilisation.
- The cost for contractor indirect costs has been included in the rates.





## **8.2.5 Owners and Engineering Design Costs**

Owners costs have been excluded from the estimate.

Engineering costs have been included in the cost estimate as a percentage of the direct costs.

## **8.2.6 Contingency**

A contingency of 25% of the direct costs has been included for anticipated, but undefined costs.

## **8.2.7 Exclusions**

The following items are outside of Advisian's scope of work and will be excluded from the estimates:

- Logistic studies;
- GST or VAT on imported goods;
- Operating shutdown costs;
- Changes to industrial relation laws;
- Abnormal weather conditions;
- Sunk costs (e.g. cost of this, previous or future studies);
- Soil remediation for any in-situ contaminants;
- Foreign exchange fluctuations;
- Project escalation; and
- Landscaping components including 5x5m signage structure / shelter, mangrove FRP boardwalk, and landscaped areas.

## 9 Multi-Criteria Analysis

A qualitative multi-criteria analysis has been conducted for the different concept options described in Section 6, and summarised in Table 9-1. Note that the repair and ongoing maintenance of the existing pontoon option has not been included in the multi-criteria analysis as it is dependent on the Shire's available budget and scope of repairs.

**Table 9-1 Multi-Criteria Analysis**

Criteria	Option 1 Floating Pontoon	Option 2 Fixed Sloping Low Level Jetty	Option 3 Alternative Location – Revetment Option	Option 4 Alternative Location – Sheet Pile Wall Option
Perceived positive attribute				
Perceived neutral attribute				
Perceived negative attribute				
'Safe' harbour as defined by Design of Marinas (AS 3962)	No – Due to exposed location (strong currents and waves). Note that the existing facility is used by users daily with only some delays / incidents.		Yes – Sheltered environment provided	
Boat Launching and Retrieval	Ramp: improved and lengthened.		Calmer environment than existing layout making boat launching and retrieval easier and safer. Steeper ramp and shorter pontoon could be used.	
	Structure: similar to existing arrangement.	Greater potential for vessels to become damaged if they do not use the facility correctly.		
Mooring of vessels	Improved fenders and mooring points.	Improved fenders and mooring points.	Improved fenders and mooring points.	



Criteria	Option 1	Option 2	Option 3	Option 4
		Locations where vessels can moor will be dictated by the tide. 'L' Pontoon not feasible in this option.		
Floating Debris	Debris can gather on the pontoon. Damage to pontoon may occur.	Less potential for damage to occur compared to Option 1. Greater potential for debris to clear during a tidal cycle.  Potential for debris to gather on the jetty depending on the tide. Less than floating option.	Debris will be greatly minimised near the ramp. Some debris may occur near entrance.	Debris will be minimised near the ramp. Some debris may occur near entrance. Less debris than Option 3.
Waves	Similar to existing arrangement, pontoon may experience significant movement during a storm event.	Fixed structure will not move in waves.	Sheltered environment, reduced waves.	
Current	Similar to existing arrangement.		Sheltered environment, reduced currents.	
Crocodiles	Similar to existing arrangement. Users mentioned that crocodiles do not generally come on to pontoon.	Crocodiles may climb / swim on to jetty, given adjacent concrete ramps.	Similar to existing arrangement. Users mentioned that crocodiles do not generally come on to pontoon.	
Sea Level Rise	Minimal impact.	Moderate impact as it would be very difficult to adjust jetty level in the future.	Minimal impact.	



Criteria	Option 1	Option 2	Option 3	Option 4
Geotechnical Aspects	Longer piles than Option 2 required, due to larger loads.	Shorter piles than Option 1.	Further Geotechnical investigations required. Challenging geotechnical conditions due to thick layer of marine sediments. Compacted fill may be required under ramp and vehicle access areas. Flat batter slopes for revetment may be required.	Further Geotechnical investigations required. Challenging geotechnical conditions due to thick layer of marine sediments. Compacted fill may be required under ramp and vehicle access areas. The size and requirement for anchor walls will need to be assessed based on the geotechnical investigation.
Acid Sulfate Soils (ASS)	There is a high probability of occurrence of Acid Sulfate Soils (ASS). Further testing is required to confirm presence of ASS and required ASS Management Plan depending on proposed works and level of soil disturbance.			
	Minimal disturbance of soil anticipated.		The inland options will require excavation of a significant amount of soil. If ASS is present, mitigation and/or treatment of the soil will be required.	
Coastal Process / Sediment Transport	Minimal impact to existing sediment transport process.		Further studies required to assess impact.	Further studies required to assess impact. Less sedimentation to Option 3.
			Sedimentation at entrance can be expected, requiring maintenance dredging.	
SWEKS's Landscape Concept for Anthon's Landing Area	Concepts fit into the proposed landscape master plan of the Anthon's Landing Area		The proposed location is located further away from Anthon's landing.	

Criteria	Option 1	Option 2	Option 3	Option 4
Aboriginal heritage	Low risk from Desktop study conducted.		Desktop and risk assessment would need to be conducted. Proposed location outside of existing desktop report area.	
Environmental approvals	Minimal environmental impact.		Large disturbance footprint. Impact on mangroves.	Large disturbance footprint (less than revetment Option 3). Impact on mangroves.
Shire vested land	Small portion (S parking area) would need to be vested to the Shire from Crown Land.		Unkown.	
Constructability & effect on current users during construction.	Users will be affected as one ramp may not be in use during construction and the pontoon / jetty will not be available during construction. Depending on the Contractors installation method the entire facility may be closed to the general public for a period of time.		Existing facility could be used during construction.	
Inspection, maintenance and durability	If a proprietary pontoon system were used, spare parts could be available. Good corrosion durability could be achieved if structural framing of pontoon was marine grade aluminium with adequate detailing for stainless steel bolted connections (to minimise corrosion of dissimilar metals).	If FRP or stainless steel reinforcing was used in the concrete deck units, ongoing maintenance costs would be minimal. Structure would be more resilient to extreme events and debris loading, reducing maintenance / repair costs.	Pontoon located in a sheltered environment. Lower maintenance expected compared to Option 1. Revetment and sheet pile wall should require minimal maintenance for a 25 year design life.	



Criteria	Option 1	Option 2	Option 3	Option 4
	<p>Damage to pontoon structure could be expected in severe debris events. As the location is exposed, greater wear and damage could be expected compared to Options 2-4. Typical proprietary pontoon systems will not be supplied with a 25 year design life.</p>	<p>Lower elevations may develop marine growth that would require cleaning at regular intervals.</p>	<p>Maintenance dredging will be required.</p>	
Stakeholder preferred option ranking	1	2	3	4
Relative CAPEX Ranking (1 Least Expensive)	2	1	<p>3-4 Far more expensive than Options 1 &amp; 2.</p>	



## 10 Recommended Concept Option

---

The concept option recommended to carry forward is the floating pontoon option located at the existing location (Option 1). This option is recommended for the following main reasons:

- The existing pontoon has performed adequately in this environment. However, it is near the end of its design life and requires replacement / extensive maintenance. A new pontoon can be provided with enhanced features (e.g. fendering, bollards, and lighting).
- The floating pontoon option was the preferred option from all stakeholder consultations.
- Has one of the lowest CAPEX estimates of the options considered.

While the floating pontoon is the preferred option, there are some negative aspects that will need to be accepted by the Shire:

- The boat ramp will not meet the tranquillity requirements of the Marina Code. The majority of the users are accustomed to the strong tidal currents and waves that occur at the boat ramp. This is more of a concern to inexperienced users.
- The pontoon will be susceptible to damage from debris.

The landside concept layout was looked upon as being favourable by most stakeholders. In order to reduce CAPEX the Shire may consider the following:

- Reducing the parking area paved with concrete paving blocks potentially using gravel road base.
- Minimise the area lighting in the parking bays.



**Advisian**  
WorleyParsons Group

**Shire of Wyndham East Kimberley**  
**Wyndham Boat Launching Facility**  
Planning & Concept Design Report



# Appendix A Stakeholder Consultations – Existing Facility

---







## A1

### Fact Finding / Lessons Learned Meeting Notes (27-28 February 2017)

Facilities Users provided the following feedback:

- Concerns regarding the condition of the existing ramp and pontoon, and funds available to perform ongoing maintenance of the facility.
- Vessels using facility:
  - Smallest vessel approximately 2.4m.
  - Largest vessel is Department of Parks and Wildlife (DPAW), approximately 10.5m. Use a very large truck.
  - Largest typical vessel is the East Kimberley Emergency Marine Rescue (EKEMR) vessel: LOA 8m, Beam 2.75m, Draft 600mm
  - Generally max draft is 500mm, or up to 700mm max if vessel has an inboard engine.
  - Usually 5 boat trailers parked. Weekends can experience up to 20-30 boat trailers.
- Local environmental conditions:
  - Large tidal range (8.7m). In king tides Foreshore Road will flood.
  - Currents of up to 6kn (3m/s) have been observed by the EKEMR. Ebb tide in wet season seems to have the strongest currents. Water will flow out of rivers and 'pile up' on flood, when tide turns the current is very strong. It has been observed that even when there are the strongest flood tides, currents will be minimal due to river discharge (i.e. flood current speed approximately equal to river discharge current speed). Can get white water around piles.
  - Hills nearby disturb the wind pattern. Often get 'Curly' wind from the north. Wind speeds of up to 70-90 kn (35 – 46m/s) have been observed. Wind from the airport is not representative of the wind direction.
  - Lots of debris (trees, etc.) come down the river and form a raft on the pontoon. Debris can be approx. 1.5m thick (below water line). Generally worse from the southern direction (source of debris) and during the wet season. Debris will get caught in the structure and has caused damage in the past.
  - Estuarine crocodiles present on site. Generally do not come as high as the car park.
- Use of existing facility:
  - Existing layout has enough room to manoeuvre vehicles and trailers on/off ramp. Sometimes there are difficulties if cars are parked where they should not be.
  - Tidal currents can be very strong. Boats are launched and retrieved on the leeward side of the current. Once launched / prior to retrieval, usually tie up to the pontoon with a single line off the bow and let vessel swing in current. Smaller vessels are pulled onto trailer with winch, larger vessel motor on to the trailer.
  - When currents are strong, and vessel is on the wrong side of pontoon, they can be pushed/pinned against the structure. Some smaller vessels have become stuck under the pontoon.



- Issues with the existing facility:
  - The existing pontoon was installed approximately 20 years ago. It was originally moored with 'bungy' type mooring lines.
  - Piles were installed using an excavator, date unknown. Some piles have failed during a storm when a vessel broke from its moorings and ran into the pontoon structure.
  - Existing pontoon used to be longer. Was damaged by debris. Debris gets caught in the pontoon. The pontoon needs to be lifted to remove larger debris.
  - Pontoon is very 'lively' and users need to use handrails in storm events. Will move around a lot in vertical direction and pitch in swells from the north west. Waves will overtop pontoon.
  - In high tides the ramp leading to the pontoon is too steep.
  - The pontoon fender line is too far from the ramp kerbs.
  - The piles are located outside of the pontoon and make berthing difficult to larger vessels.
  - Existing extruded aluminium mesh is rough on feet and footwear as the holes are too large.
  - North ramp cannot be used at low tides due to 'L' pontoon being too close. The ramp is not long enough and has eroded / undermined at the end of the ramp. This can be a safety issues if currents are towards the north direction and South ramp needs to be used.
  - The existing North boat ramp is constructed using Flex Mats. Insitu ground was very soft, nearly 2m of rounded rock (50-200mm) was placed as a bedding material. Some of the concrete units (at approximately MSL) have come off and are a tripping hazard. The north concrete kerb of the North ramp has been damaged by vessel and propeller impact.
  - South ramp is generally in good condition and serviceable. End of the ramp could be extended for low tides. End of the ramp is constructed of rock, with a steepened slope which is manageable for users.
  - Both ramp widths are adequate.
  - The existing flood light is not positioned correctly and can be blinding to people arriving in the evening on their boat and is dependent on the tidal level.
  - The existing trailer parking bay has been constructed on reclaimed land has some soft spots that tend to be avoided by cars.
- Upgrades to consider in concepts:
  - Upgrades to lighting. Have lighting at end of ramp or solar powered units similar to Anthon's Landing jetty.
  - Upgrade decking / mesh. FRP micro-mesh could be acceptable, but use light colours to reduce heat.
  - Maintain barge landing ramp.
  - Extend pontoon and shift 'L' pontoon further.
  - Provide additional bollards for mooring.



**Advisian**

WorleyParsons Group

**Shire of Wyndham East Kimberley  
Wyndham Boat Launching Facility  
Planning & Concept Design Report**



- Stability of pontoon and fender position / free-board for smaller vessels such that they do not go under pontoon.
- The existing Foreshore Road brick pavement has performed well and to be considered in parking areas.
- Upgrades to pavement / gravel surface of the parking areas.
- Consider a compostable toilet to replace existing toilet block.
- Consider fish cleaning station and rubbish bins.
- Consider a boat cleaning bay.
- Consider foreshore landscaping upgrade study in concept design.



## A2

### Questionnaire – Public Feedback on Existing Facility

A summary of the feedback received is as follows:

- Vessel length, tow vehicle and trailer:
  - All respondents use 4x4 vehicles to tow their boat trailers.
  - Typical 5m long vessels are transported on single axel trailers.
  - Typical 6-8m long vessels are transported on double axel trailers.
  - The largest vessel was 11m, transported on a quad axel trailer.
- Suggested landside improvements:
  - More manoeuvring room at top of ramp (requested by the EKVMR).
  - Improved car parking / sealed surface.
  - Improve parking such that trailers do not encroach on the road (shift parking towards mangroves).
  - Cleaning bay with fresh water for trailer, boat, truck washdown. The toilet block near Anthon's Landing has water; the EKVMR shed also has high pressure water.
  - Fish cleaning station with bins.
- Suggested boat ramp and marine structure improvements:
  - Rough conditions and inexperienced users can cause delays.
  - Loading of adjacent barge ramp can cause delays.
  - Mud build-up on ramp, but still able to use facility.
  - Debris and tidal conditions may mean 1 ramp can only be used.
  - Ramp is not steep enough, can immerse car in water.
  - Approximately 30m extension on ramps to improve access at low tides.
  - North ramp is not long enough (tidal restrictions) and large drop-off at end.
  - The end 'L-pontoon' can cause problems at lower tide levels. Extend the pontoon and consider using a 'T' head at end (easier for N+S ramp). Extend length of the 'L' to allow for greater number of boats to moor.
  - North ramp is damaged and should be addressed asap.
  - Piles located inboard of pontoon.
  - Wider pontoon, central hand rail.
  - Improved handrails, walkway can be very slippery at times, better security for crocodiles.
  - Improved fendering.
  - Improved lighting, particularly at the seaward end of the pontoon.



## Questionnaire

Have your say about the facilities provided at Wyndham Boat Ramp and Floating Pontoon.

### 1. BOAT RAMP

How often do you use the boat ramp?	<input type="checkbox"/> X Per Week	<input type="checkbox"/> X Per Month	<input type="checkbox"/> X Per Year
Do you have difficulties launching or retrieving your boat?	<input type="checkbox"/> Yes	<input type="checkbox"/> No	Comment Below
Do you consider the facilities adequate?	<input type="checkbox"/> Yes	<input type="checkbox"/> No	
Is the turnaround at the top of the ramp adequate?	<input type="checkbox"/> Yes	<input type="checkbox"/> No	
Is there sufficient area for rigging and derigging?	<input type="checkbox"/> Yes	<input type="checkbox"/> No	
Do you experience delays when you use the facilities?	<input type="checkbox"/> Yes	<input type="checkbox"/> No	Comment Below
What size equipment do you use at the facility?	Boat Size	Trailer Axle/s	Vehicle Type

What is the cause of these delays?

.....  
 .....

What difficulties have you had launching or retrieving your boat?

.....  
 .....

Do you have suggestion to improve the boat ramp facilities?

.....  
 .....



**Advisian**  
WorleyParsons Group

**Shire of Wyndham East Kimberley**  
**Wyndham Boat Launching Facility**  
Planning & Concept Design Report



## **Appendix B    Basis of Design**

---





## 1 Design Codes and Standards

---

The facilities are to comply with appropriate Australian standards including:

- Guidelines for Design of Marinas (AS 3962)
- Guideline for Maritime Structures (AS 4997)
- Universal Access Design (AS 1428)
- Structural Design Actions (AS 1170)
- Guidelines for the Design of Boat Launching facilities in Western Australia below the 25<sup>th</sup> Parallel (DoT, 2009)

## 2 Design Life

---

The design life of all structural items shall be 25 years.

The design life for pavements shall be 25 years.

The design life of the overall facility shall be 25 years.

The design life assumes regular and routine maintenance inspections are carried out in accordance with approved procedures as determined by SWEK.

Depending on the selected option, the design life of particular components may need to be revisited. For example, if a proprietary floating pontoon option is selected, suppliers may not provide a 25 year design life for the entire pontoon system (10-15 year design life is typical).

## 3 Structural Importance Level

---

Due to the level of use, the facility poses a low degree of hazard to life. However, due to the remote location and mobilisation costs to construct the facility, the cost to replace the structure may be considerable.

The facility should be designed for an Importance Level / Functional Category of 2.

Depending on the selected option the structural importance level of particular components may need to be revisited. For example, if a proprietary floating pontoon option is selected, a structural importance level of 1 may be appropriate for the floating pontoons, while the structural piles should be designed for an importance level of 2.

## 4 Datums

---

The horizontal datum is to Map Grid of Australia, MGA94 Zone 52 (GDA94).



The vertical datum shall be to Wyndham Chart Datum (CD), which is 4.4m below Australian Height Datum (AHD) 1994.

## 5 Safety

---

All design will be in accordance with Australian Standards and generally accepted practices for marine structures in accordance with AS 3962 and AS 4997 guidelines.

Handrails and/or guard-railing and ladders will be provided where necessary.

## 6 Universal Access

---

The marine structures including the boat ramp and jetty/pontoon will not be designed to superficially cater for universal/disabled access. It is assumed that all vessels using the facility that will require universal/disabled access will have a suitable gangway and/or will use the nearby floating pontoon at Anthon's landing. During some low tide events, the jetty/pontoon may exceed the maximum gradient of 1:14 as prescribed in AS 1428.

Cross walks and footpaths in the car / boat trailer parking area, where provided, will cater for disabled access.

## 7 Environmental Impact Assessment

---

An Environmental Impact Assessment (EIA) has not been conducted as part of this concept study.

Reference can be made to "Proposed Community Jetty, Anthon's Landing, Environmental Impact Assessment, March 2010, Nicole Siemon and Associates PL" for general environmental impacts that may be applicable for this development.

## 8 Environment

---

### 8.1 Climatic Conditions

As a guide to the ambient conditions, the following information is provided (Source: Australian Government Bureau of Meteorology (BOM) website, taken from the nearest weather station at the Wyndham Airport, Site Number 001006):

Mean Maximum Temperature	39.9°C (in November)
Highest Recorded Temperature	45°C
Mean Daily Minimum Temperature	15.3°C (in July)





Lowest Recorded Temperature	5.1°C
Relative humidity	up to 70%
Mean yearly rainfall	844mm
Maximum daily rainfall	229mm

## 8.2 Wind

There are no measured wind data at the Wyndham Boat Ramp location with a sufficiently reasonable resolution. Wind conditions shall be assessed based on AS/NZS 1170.2 and BOM wind station at Wyndham Airport.

### 8.2.1 Structural Design Wind Speeds

The wind design parameters and criteria for the design of the structural design of permanent facilities will be in accordance with AS/NZS 1170.2.

Importance Level	2 (refer to Section 3)
Average Probability of Exceedance (Ultimate Limit State)	1/250
Average Probability of Exceedance (Serviceability Limit State)	1/25
Region	C
Ultimate 3 sec Gust Wind Speed (1/250)	$V_R = 65\text{m/s}$ (126 knots)
Serviceability 3 sec Gust Wind Speed (1/25)	$V_R = 47\text{m/s}$ (91 knots)

### 8.2.2 Coastal Study Wind Speeds

This section is applicable for the wind speeds used to determine the site specific wave heights and currents. Full details and description of how the wind speeds were determined can be found in the Coastal Desktop Study, contained in Appendix C.

Serviceable wave height:	1 year ARI – 16 m/s (hourly wind speed)
Extreme wave height:	250 year ARI – 40 m/s (hourly wind speed)

## 8.3 Cyclonic Conditions

The facilities shall not be operational under cyclonic conditions.



## 8.4 Earthquake

The seismic design criteria for the design of the facilities will be in accordance with AS/NZS1170.1, AS1170.4 and AS4678.

Importance Level	2
Average Probability of Exceedance (Ultimate Limit State)	1/250
Average Probability of Exceedance (Serviceability Limit State)	1/25
Probability Factor	$k_p = 0.75$
Hazard Factor	$Z = 0.09$
Soil Class	$D_e / E_E$ (TBC)
Earthquake Design Category	EDC-II

## 9 Oceanographic

### 9.1 Tidal Ranges and Water Levels

The ambient tide range for the area is listed in Table 9-1, and based on the DOT submergence curve for Wyndham (DOT 696-80-01, April 2010), and shown in Figure 9-1.

**Table 9-1 Tidal Levels**

Tidal Level		Elevation m CD
Highest Astronomical Tide	HAT	8.70m CD
Mean High Water Spring	MHWS	7.77m CD
Mean High Water Neap	MHWN	6.00m CD
Mean Sea Level	MSL	4.56mCD
Australian Height Datum	AHD	4.44mCD



<b>Tidal Level</b>		<b>Elevation m CD</b>
Mean Low Water Neap	MLWN	2.93m CD
Mean Lower Water Spring	MLWS	1.18m CD
Lowest Astronomical Tide	LAT	-0.01m CD

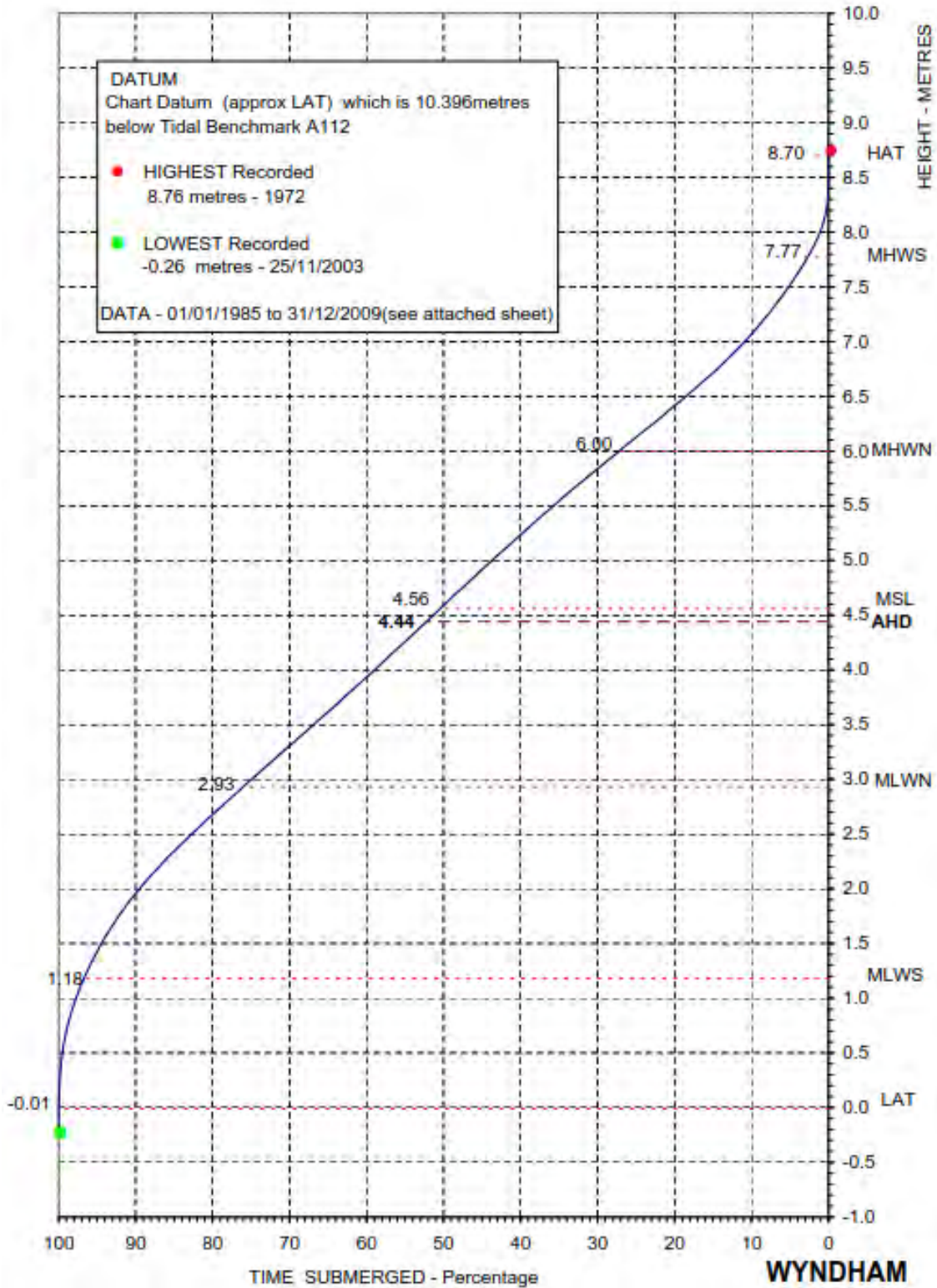


Figure 9-1 Wyndham Submergence Curve (Ref. DoT 696-80-01, April 2010)

## 9.2 Waves

The site specific waves were assessed as part of the Coastal Desktop Study, as contained in Appendix C. The design wave heights are summarised in Table 9-2.

**Table 9-2 Wave Parameters at Wyndham Boat Ramp**

ARI (Years)	Significant Wave Height (m)	Peak Wave Period (s)
1	1.3	4.3
250	2.7	5.5

## 9.3 Currents

The site specific currents were assessed as part of the Coastal Desktop Study, as contained in Appendix C. The currents at the site are strongly influenced by the combination of tidal and river discharge during the wet season.

Tidal currents, wave induced currents and currents from river flow have been assessed separately. Tidal currents are strong compared to wave induced currents and currents due to river flow. It is recommended to consider combined maximum currents as follows:

Ebb Tide	= 2.0 m/s
Waves	= 0.4 m/s
River Flow	= 0.4 m/s
Total	= 2.8 m/s

During the stakeholder consultation, fact finding and lessons learned session conducted on 27 February 2017, it was informed that currents up to 6 knots (3.1m/s) were observed. The present assessment provides approximately similar maximum current speed at Wyndham Boat Ramp for ebb tide.

## 9.4 Sea Level Rise

Guidance for sea level rise is provided in "Sea Level Change in Western Australia – Application to Coastal Planning," 2010, DoT, Coastal Infrastructure, Coastal Engineering Group. Assuming that the



facility will be upgraded by 2020, and for a 25 year design life (year 2045), DoT recommends adopting a sea level rise of 0.2m.

Due to the existing site level constraints given the existing Foreshore Road is slightly below HAT, the effect of sea level rise may not be able to be taken into account for the trailer parking areas / foreshore development. The effect of sea level rise shall be considered for any floating structures or were the existing site levels can be modified with only minimal impact to existing infrastructure.

## 10 GEOTECHNICAL

---

Refer to the Section 2 for a list of available geotechnical information

## 11 Marine Structures

---

### 11.1 General

Factored loads will be applied in accordance with the design codes, to give the least favourable combinations.

New structures shall consider the following loading:

- a. Dead loads;
- b. Live loads;
- c. Wind loads;
- d. Earthquake loads;
- e. Wave impact loads;
- f. Current and debris loads;
- g. Mooring loads;
- h. Berthing loads;
- i. Temporary construction loads;
- j. Dynamic allowance: For structures carrying live loads which are of a dynamic nature, the structural elements will be designed to support a moving live load, to account for the dynamic effects; and
- k. Thermal: Load effects on structures resulting from expansion or contraction of materials due to temperature changes will be allowed for where appropriate.

All deflections will be as stipulated in the relevant standards.



## 11.2 Design Live Loads

The proposed jetty / pontoon shall be designed for unrestricted access (i.e open to public). The design live loads are as per AS 3962 and summarised in Table 11-1.

**Table 11-1 Design Live Loads**

Structure Type	Uniformly Distributed Load	Point Load
Fixed Structure	5 kPa	4.5 kN
Gangway	4 kPa	4.5 kN
Floating	3 kPa	4.5 kN

## 11.3 Berthing Loads

For the berthing load a 4 tonne displacement vessel at 0.3m/s shall be assumed. This is slightly larger than the design vessel (see Section 11.7) in terms of its displacement but is to take into account variability in vessels using the facility.

## 11.4 Debris Loads

The pontoon or jetty structure shall be designed for debris mats that may form along the structure.

The minimum debris mat thickness is 1.5m.

The minimum load shall be as calculated as per the Bridge Design Part 2: Design Loads (AS 5100.2), or 10 kN per meter of structure.

Impact from logs shall be considered as per AS 5100.2.

## 11.5 Negative Lift Due to Currents

Negative lift due to currents shall be considered. Refer to AS 4997 and AS 5100.2 for further guidance.

## 11.6 Floating Pontoon Stability

Floating pontoons shall be designed for sufficient stability as per AS 3962.



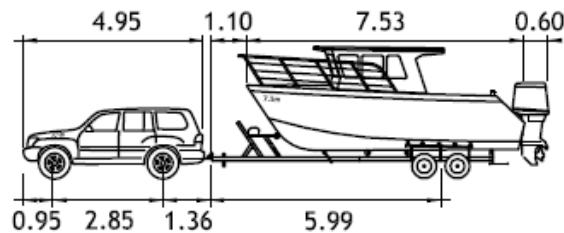
## 11.7 Design Vessel

The design vessel is based on a rescue vessel used by the East Kimberley Marine Rescue as follows:

- Length – 8.9m
- Breadth – 2.75m
- Draft- 0.6m
- Vessel weight – 3.7 tonnes

## 11.8 Vehicle and Boat Trailer

The boat ramps will be designed to allow for the use of a 4 wheel drive car with a 6.5m trailer to cater for a vessel of up to 8.9m in length, as noted in Figure 11-1 and the DoT "Guidelines for the Design of Boat Launching Facilities". This vehicle and boat trailer arrangement is similar to the East Kimberley Marine Rescue arrangement.



4 Wheel Drive-Boat 7.5m

CAR Width	: 1.94	Lock to Lock Time	: 6.00
Trailer Width	: 2.50	Steering Angle	: 40.0
CAR Track	: 1.61	Articulating Angle	: 70.0
Trailer Track	: 2.22		

### LARGE CAR/TRAILER UNIT

Figure 11-1 4-Wheel Drive Vehicle with Trailer (Ref. DoT)

## 11.9 Boat Ramp and Marine Structure Levels

The top of the boat ramps and jetty/floating pontoon will be designed to tie into the adjacent landside levels.

The lower elevation of the boat ramps shall be 0.6m below LAT (as per DoT recommendations). Due to the large tidal range, and rare occurrence of low tides (< 5% occurrence of MLWS) this level may be revisited during the detailed design phase in order to reduce the cost of the boat ramp.





## 11.10 Navigational Aids

The need for navigational aids is to be considered and may be required depending on the concept options proposed.

# 12 Landside Works

## 12.1 Car Park

The facility is located in a rural environment, with existing parking provided on reclaimed land near to the north and south of the boat ramp. Reference is made to AS 3962 for the amount of trailer bays required for a public boat launching ramp facility, and summarised in the Table 12-1.

**Table 12-1 Parking at Public Boat Launching Ramp – Rural Area (Ref. AS 3962)**

Number of car/trailer spaces for each ramp lane		
Ramp only	With boat holding structures	With separate rigging and derigging areas
20-30	30-40	40-50

DoT guidelines state that 50% of parking area should be paved.

For Wyndham Boat Launching Facility the following considerations are applicable:

- While there are 2 ramps present (north and south ramps), only one ramp can be used due to tidal restrictions (i.e. vessels need to be launched / retrieved on the leeward side of the current).
- The pontoon structure / proposed jetty does not act like a typical holding jetty, in that it is required more for safety reasons due to the large tidal range, strong currents requiring vessels to tie onto the structure to assist in retrieving vessels, and risks associated with crocodiles.
- Rigging / de-rigging bays are to be considered to north and south side of entrance to ramp. This will help with excessive wear on gravel pavements, while also allowing for temporary parking areas for rigging/derigging.

Based on the above, the concept layouts shall allow for approximately 40 trailer parking bays.

The parking and manoeuvring areas for the boat trailers shall be capable of catering for a 4 wheel drive car towing a 6.5m trailer with boat and motor (refer to Section 11.8).



## 12.2 Landscaping

The concept design should consider potential landscaping in the future, subject to available funding sources. The following are to be considered:

- Anthon's Landing – Landscape Concept Report by Blackwell & Associates Pty, refer to Figure 12-1.
- 5m x 5m shelter to be provided by DEPOL near the boat ramp.

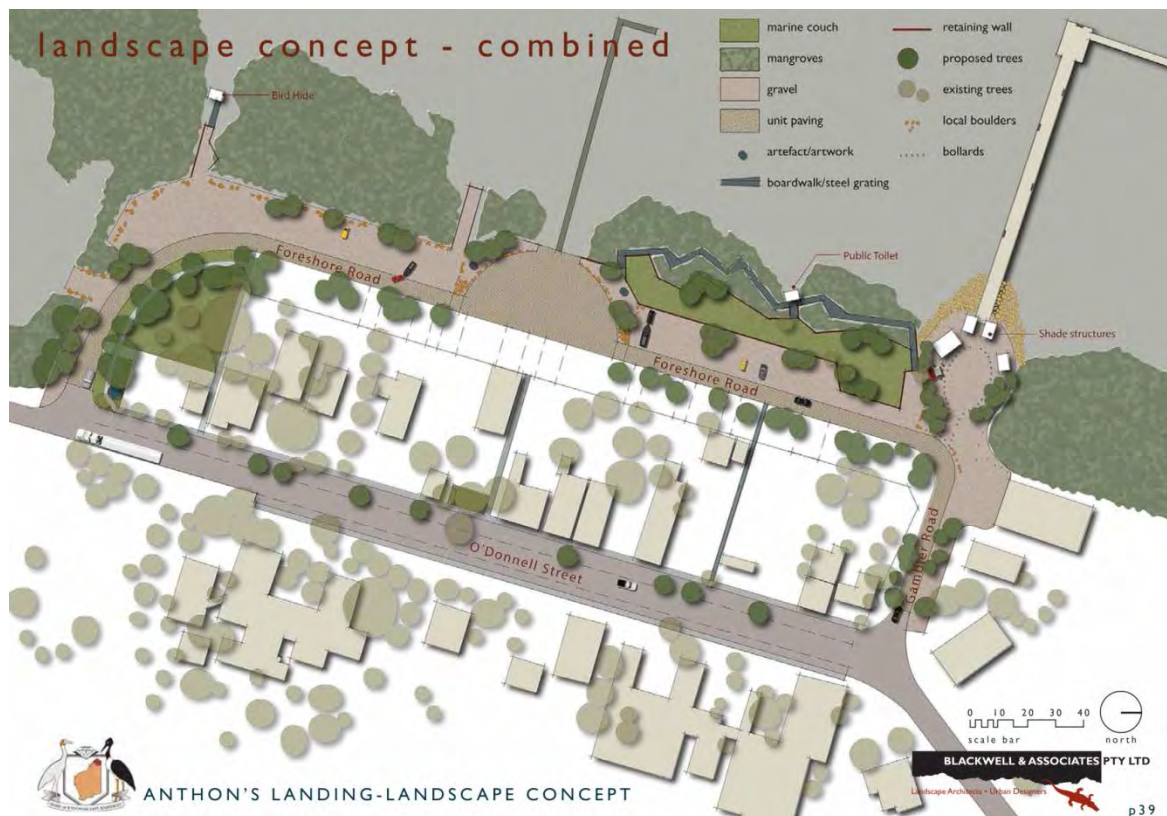


Figure 12-1 Anthon's Landing – Landscape Concept (Ref. Blackwell & Associates)

## 13 Design for Durability

### 13.1 Protection of Steelwork

A corrosion allowance of 2mm shall be considered for all marine structures.

All steelwork (unless buried by more than 1 m) shall be painted. Paint system shall be Interzone 954HS or similar approved, in two layers totalling 500 microns.

Piles shall be additionally protected by HDPE sleeves or bitumen tape wrapping.



**Advisian**

WorleyParsons Group

**Shire of Wyndham East Kimberley**  
**Wyndham Boat Launching Facility**  
Planning & Concept Design Report



Cathodic protection systems are to be considered depending on structural system selected.

## **13.2 Concrete**

Exposure classification as per AS 4997 shall be applied.

Due to the environment and difficulty in conducting repairs at low tidal levels, FRP and stainless steel reinforcement is to be considered.

Where mild steel reinforcement is used, appropriate cover, concrete strength and admixtures are recommended.



**Advisian**  
WorleyParsons Group

**Shire of Wyndham East Kimberley**  
**Wyndham Boat Launching Facility**  
Planning & Concept Design Report



## Appendix C Coastal Desktop Study

---





## TECHNICAL NOTE

**DATE** 8 May 2017

---

**TO** Chris Meisl

---

**FROM** Anuja Karunarathna

---

**COPY**

---

**PROJECT** 301320-14638

---

**SUBJECT** Wyndham Boat Ramp - Coastal Desktop Study

---

**DOC NO** 301320-14638-CO-MEM-001 Rev 0

---

## INTRODUCTION

This document presents the coastal assessment conducted to estimate wave and current conditions at Wyndham ramp (Figure 1 and Figure 2).





**Figure 1 Area of Wyndham and BOM Weather Stations**



**Figure 2 Wyndham ramp location**

## **SCOPE OF WORK**

A limited coastal study has been conducted to make an assessment of current and wave conditions at the site. This includes:

- Wind inputs based upon Australian Standards (AS-NZS 1170-2) and Bureau of Meteorology (BOM);
- Wave conditions estimated from fetch limited analysis and a spectral wave model;
- Tidal current velocities based upon available measurements and literature;
- Wave generated current velocities based upon available empirical formula; and
- River flow velocities estimated from available river discharge information.

The assessment has been conducted based on several assumptions. Further coastal studies may be required during the detailed design stage.



## **ASSUMPTIONS**

Following assumptions are made for the present assessment:

- There are no measured wind data at Wyndham ramp location with a sufficiently reasonable resolution. Wind conditions are assessed based on AS-NZS 1170-2 and BOM wind station at Wyndham Aero;
- The fetch limited wave assessment assumes uniform depth along fetch lengths;
- Tidal, wave induced and river flow current velocities are separately assessed based on available information, assumptions as mentioned in each section and empirical formula.

## **WIND DATA**

The BOM has three wind stations in the vicinity of Wyndham ramp. These include Wyndham Port (Station 001005), Wyndham (Station 001013) and Wyndham Aero station (001006) as presented in Figure 1. BOM has wind data for Wyndham Port from 1957 to 1967 but only two observations per day were recorded. The wind records for Wyndham covers data period from 1967 to January 2015 but has only two and seven observations per day with the most recent data at 9am/3pm only. Wyndham Aero has hourly data from 2000 to the present and this data set was purchased for this project.

Wyndham Aero is located at a sheltered location for wind from the North compared to Wyndham ramp and the wind conditions at this station may be slightly different to wind conditions at Wyndham ramp.

Figure 3 and Figure 4 presents the wind rose diagrams as per 9am and 3pm observations, respectively at Wyndham Port, Wyndham and Wyndham Aero as per BOM website. It is observed that daily wind cycles at Wyndham Port represent North-South and Northwest-Southeast directions. At Wyndham and Wyndham Aero stations, wind from East and Northeast are dominant over wind from North due to sheltering effect from terrain to the North of the stations.

Figure 5 presents the wind rose diagram for hourly wind data for Wyndham Aero. Corresponding omni-directional extreme wind speeds for 1 year (operational) and 250 year (extreme) Average Return Intervals (ARI) are presented in Table 1.

Extreme cyclonic wind speeds assessed based on AS-NZS 1170-2 for Wyndham are also presented in Table 1. These wind speeds represent the cyclonic wind speeds presented in AS-NZS 1170-2 (Region C) multiplied by terrain height multiplier for Category 2 and converted in to hourly wind speeds.

It is observed from Table 1 that estimated extreme wind speeds at Wyndham Aero are significantly lower than cyclonic wind speeds assessed from AS-NZS 1170-2.

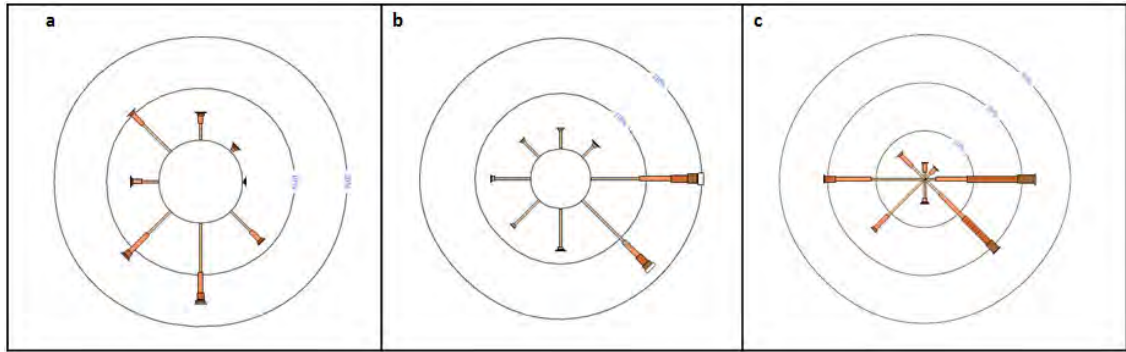


Figure 3 Wind rose diagrams for (a) Wyndham Port, (b) Wyndham and (c) Wyndham Aero (9am Observations) <http://www.bom.gov.au>

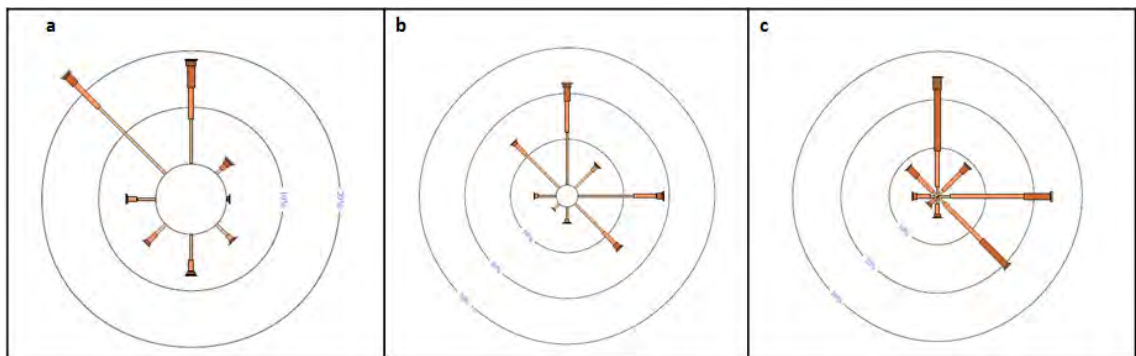


Figure 4 Wind rose diagrams for (a) Wyndham Port, (b) Wyndham and (c) Wyndham Aero (3pm Observations) <http://www.bom.gov.au>

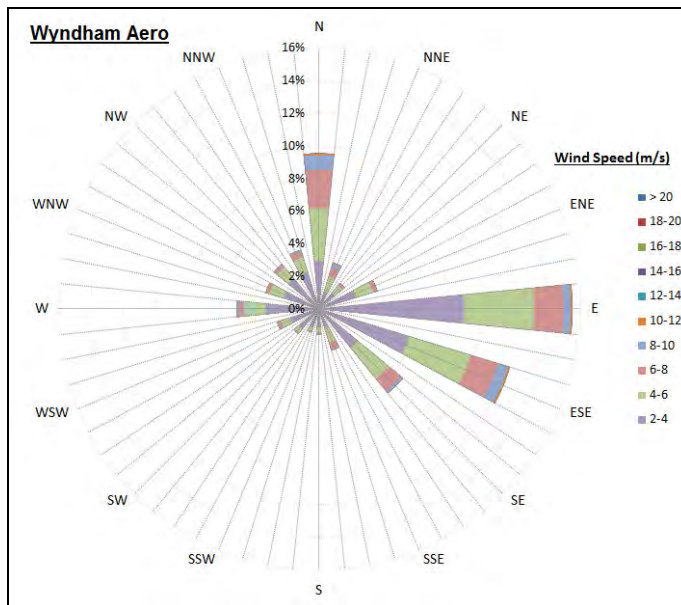


Figure 5 Wind rose diagrams hourly wind data for Wyndham Aero (2000 - March 2017)





**Table 1 Extreme hourly wind speeds for Wyndham (AS-NZS 1170-2) and Wyndham Aero (2000 - March 2017)**

Return Period (years)	Hourly Wind Speed (m/s)	
	AS-NZS 1170-2 (Region C - Cyclonic)	Wyndham Aero
1	16.1	15.5
250	40.1	24.0

Based on this assessment, the following extreme wind speeds have been considered in the wave and current assessments in this project:

- 1 year ARI – 16 m/s;
- 250 year ARI – 40 m/s.

## WAVES

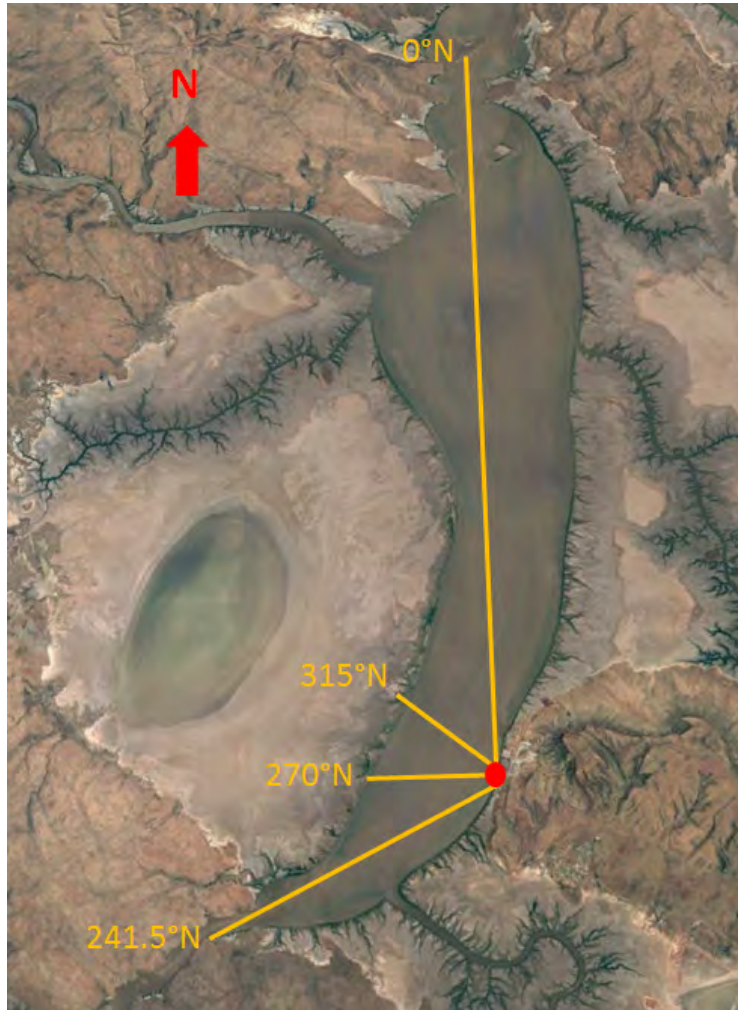
Wind induced wave conditions have been estimated by fetch limited wave analysis and a numerical spectral wave model developed using MIKE 21 software. Wind speeds of 16 m/s and 40 m/s have been considered in this assessment.

### Fetch limited wave analysis

The fetch limited wave analysis has been performed analytically by using the Jonswap analytical method (Carter, 1982) as described in Shore Protection Manual (1984) to estimate wind induced wave conditions at the Wyndham boat ramp (Figure 1). Significant wave heights and peak wave periods are calculated for directions North, Southwest (241.5°N), West and Northwest directions.

The Jonswap method estimates wave parameters (significant wave height and peak wave period) based on wind and water level parameters such as fetch, storm duration and depth of water in the generating area. Based on the size of the water body, fetch and wind duration, the generated waves are classified as fetch limited, duration limited or fully developed sea and the wave parameters are calculated, accordingly. On a small water body, the waves are limited by a short fetch whereas on a large water body, wind duration may limit the size of the waves. A fully developed sea represents a large body of water and a long duration.

The directions and fetch lengths considered in this analysis are presented in Figure 6.



**Figure 6 Directions and Fetch Lengths**

The input parameters for fetch limited wave assessment are presented in Table 2. Significant wave height and peak wave period predictions from Jonswap method for wind speeds 16 m/s (1 year ARI) and 40 m/s (250 year ARI) are presented in Table 3.

The water depth along the fetch lengths vary significantly, however, it is required to consider an appropriate representative water depth for each fetch in the analysis since this analytical method cannot consider varying water depths along fetch lengths.

**Table 2 Input parameters for Jonswap method**

Direction from North (deg)	0 (N)	241.5 (WSW)	270 (W)	315 (NW)
Fetch (km)	25.3	9.9	4.0	3.7
Water Depth at MHWS (m CD)	17.8	13.8	13.8	13.8
1 year ARI Wind Speed (m/s)	16	16	16	16
250 year ARI Wind Speed (m/s)	40	40	40	40
Wind Duration (hours)	4	4	4	4



**Table 3 Wave parameters predicted at Wyndham ramp from Jonswap method**

Direction (deg from North)	0 (N)		241.5 (WSW)		270 (W)		315 (NW)	
	Significant Wave Height (m)	Peak Wave Period (s)	Significant Wave Height (m)	Peak Wave Period (s)	Significant Wave Height (m)	Peak Wave Period (s)	Significant Wave Height (m)	Peak Wave Period (s)
1	1.3	4.6	0.8	3.4	0.5	2.5	0.5	2.4
250	3.2	6.3	2.0	4.6	1.3	3.4	1.2	3.3

### **Spectral Wave Model**

Wave conditions have been modelled by applying the spectral wave module of the MIKE 21 software package (MIKE 21 SW).

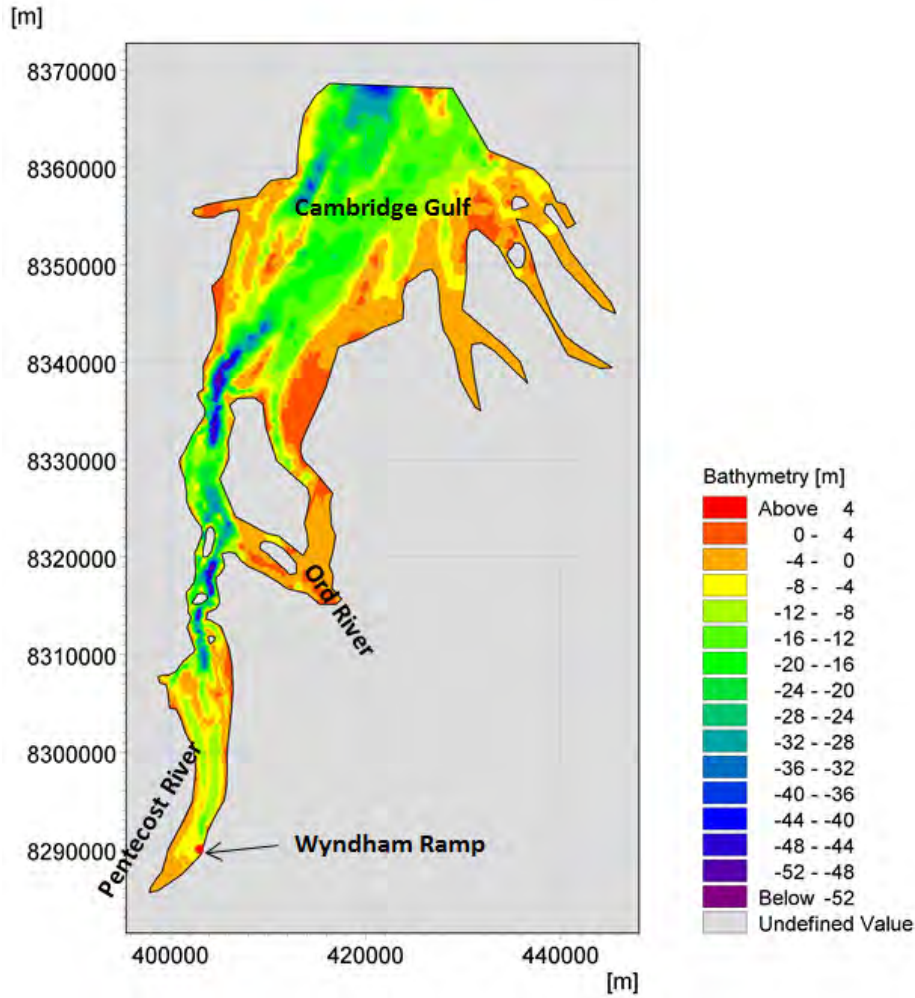
MIKE 21 SW is a third generation spectral wind-wave model based on unstructured meshes, which is particularly useful as it allows areas of interest to be refined in great detail whilst minimising computational demand. The model enables full time domain simulations and allows for the simulation of growth, decay and transformation of wind generated waves and swells in offshore, coastal and nearshore areas with a limited fetch.

The fully spectral formulation is based on the wave action conservation equation, where the directional-frequency wave action spectrum is the dependent variable. Specifically, MIKE 21 SW includes the following physical phenomena:

- Wave growth by action of wind;
- Non-linear wave-wave interaction;
- Dissipation due to white-capping;
- Dissipation due to depth-induced wave breaking;
- Dissipation due to bottom friction;
- Refraction and shoaling due to depth variations.



The bathymetry for numerical wave model for Wyndham was generated by using MIKE CMAP data and covers parts of Cambridge Gulf, Ord River and Pentecost River as presented in Figure 7. The co-ordinates are referenced to map projection MGA-52 (GDA 94) and vertical datum is referenced to Chart Datum. A Northerly wind direction has been assumed since fetch limited wave analysis predicted higher wave conditions for this direction and therefore the results can be considered to be conservative. The model simulations were run at Mean High Water Spring water level.



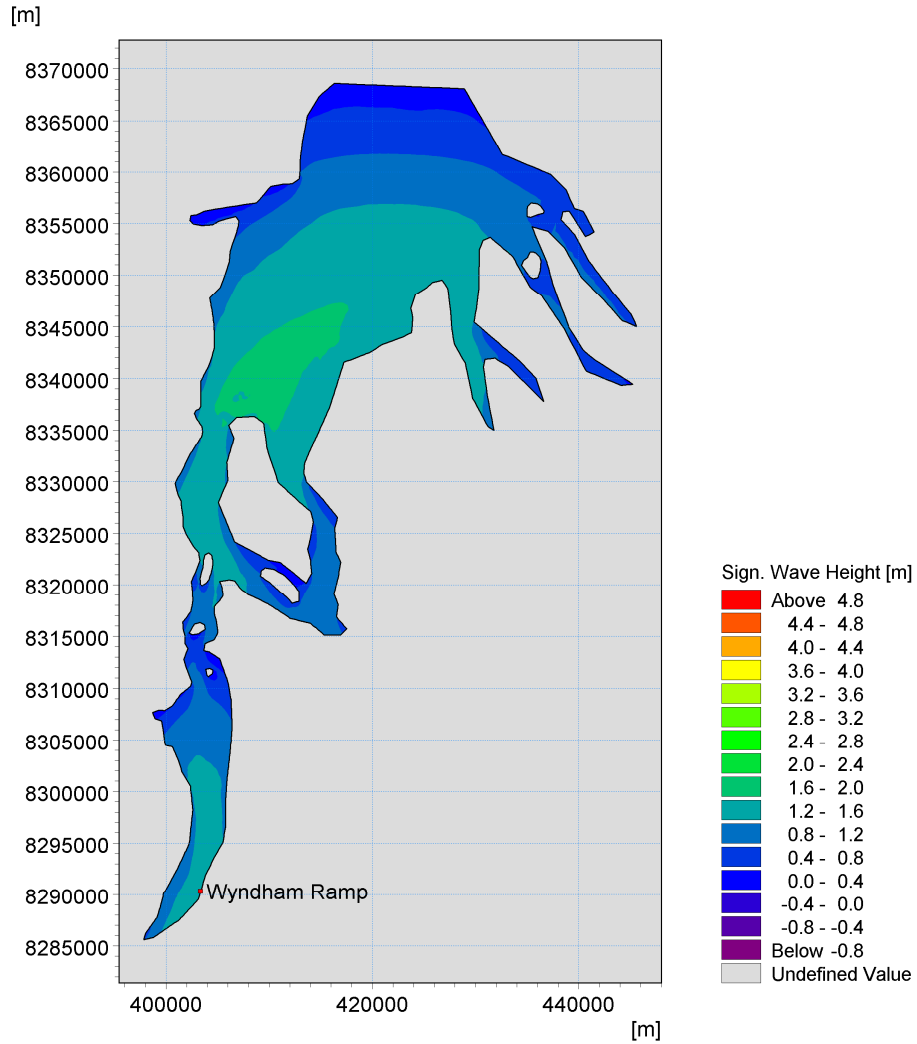
**Figure 7 Spectral wave model domain and bathymetry**

Table 4 presents the wave parameters for wind generated waves based on the MIKE 21 SW model at the Wyndham ramp for different scenarios. Corresponding significant wave height plots are presented from Figure 8 to Figure 9.

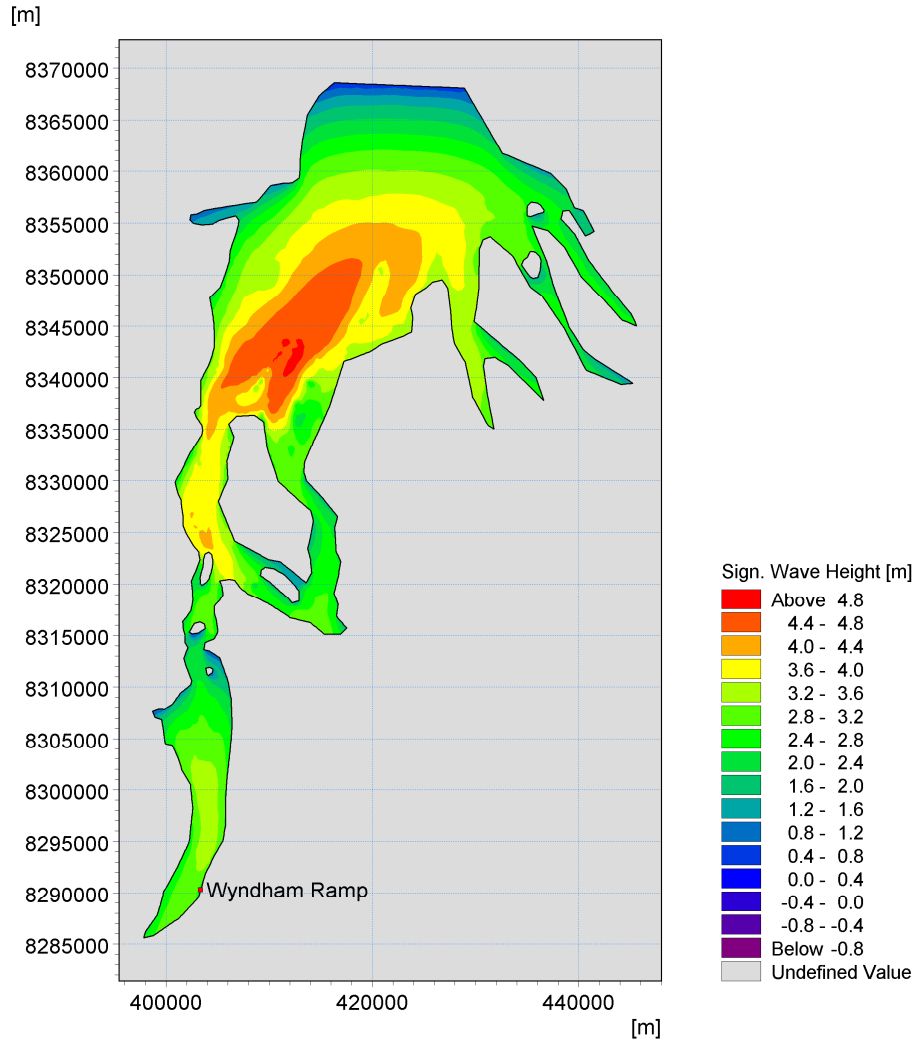


**Table 4 Wave parameters predicted at Wyndham ramp from MIKE 21 SW model**

Input Wind Speed from North (m/s)	Significant Wave Height (m)	Peak Wave Period (s)	Mean Wave Direction (deg N)
16	1.3	4.3	0
40	2.7	5.5	348



**Figure 8 Significant wave height plot for wind speed 16 m/s from North**



**Figure 9 Significant wave height plot for wind speed 40 m/s from North**

As seen in Table 3 and Table 4, it is observed that significant wave heights from the numerical model and fetch limited analysis are similar for 1 year ARI condition. Peak wave period from fetch limited analysis is slightly larger compared to the numerical model. Significant wave height and peak wave period for 250 year ARI from the numerical model are slightly lower compared to the analytical method. This is mainly due to the assumption of constant water depth along the fetch lengths considered in the analytical method and most of the wave phenomena incorporated in numerical models are not included in analytical methods. It is expected that numerical model provides more accurate results compared to analytical methods. In general, the analytical method wave height results in the present assessment are larger and could be used as a more conservative estimate if desired. Results from numerical model are chosen for the present project.

## TIDAL CURRENTS

Current velocities at Wyndham ramp has been assessed based on available literature.

The siltation study for Port of Wyndham conducted by Hydraulic Research Station (1971) reported maximum measured current speed of 2.0 m/s ebb current and 1.4 m/s flood current at a location near to the centre of the river at Wyndham Port. Float tracking carried out for an area covering upstream



and downstream of Wyndham Port jetty showed velocities up to 0.9 m/s at Wyndham ramp for ebb tide.

Wolanski et al. (2001) conducted field studies to assess sediment dynamics of the West and East arms of Cambridge Gulf. According to their measurements, the peak currents at Wyndham were larger at ebb tide than at flood tide with a ratio of 1.43 between peak currents at ebb and flood tides. Their measurements showed ebb currents up to 1.2 m/s on 28 August 1999.

Based on review of the available literature, ebb current speed of 2.0 m/s and flood current speed of 1.4 m/s are considered to be reasonable conservative estimates for tidal current speeds at Wyndham ramp.

### WAVE INDUCED CURRENTS

Wave induced current velocity is estimated based on empirical formula presented by Goda (2009). The following input parameters have been considered:

- Seabed slope = 1:45
- Incident wave angle =15°

The wave induced maximum current speeds estimated for extreme wave conditions presented in Table 4 are presented in Table 5. The maximum wave parameters estimated from fetch limited analysis and spectral wave model for each wind condition are considered.

**Table 5 Wave induced current velocity estimated at Wyndham ramp**

Input Wind Speed from North (m/s)	Significant Wave Height (m)	Peak Wave Period (s)	Maximum Wave Induced Current Velocity (m/s)
16	1.3	4.3	0.29
40	2.7	5.5	0.42

### CURRENTS FROM RIVER FLOW

The current speed at Wyndham ramp due to river flow is estimated based on available information on river discharge, discharge periods and cross sectional area of the river at Wyndham ramp. Wolanski et al. (2001) mentioned the annual discharge of Durack and Pentecost rivers is approximately  $2.8 \times 10^9 \text{ m}^3$  and most of this discharge occurs between January and April. According to available records from BOM, the peak combined discharge from Durack, Pentecost rivers and other tributaries are estimated as  $5,000 \text{ m}^3/\text{s}$ .

The mean and peak current speeds due to river flow are estimated as follows:

- Cross sectional area of the river at Wyndham boat ramp =  $14,000 \text{ m}^2$  (estimation based on CMAP data)
- Annual discharge from the river =  $2.8 \times 10^9 \text{ m}^3$
- Number of discharge days per year from BOM = 60 days (estimate based on “days of rain” maps)
- Mean discharge =  $2.8 \times 10^9 \text{ m}^3 / (60 \times 24 \times 3600) \text{ s} = 540 \text{ m}^3/\text{s}$



- Approximate mean current speed =  $540 \text{ m}^3/\text{s} / 14,000 \text{ m}^2 = 0.04 \text{ m/s}$
- Approximate peak current speed =  $5,000 \text{ m}^3/\text{s} / 14,000 \text{ m}^2 = 0.4 \text{ m/s}$

## RECOMMENDATION

Wave conditions at Wyndham ramp has been assessed based on an analytical wave hindcast method and a numerical spectral wave model. The numerical model provides similar significant wave height for 1 year ARI condition and slightly lower wave parameters for 250 year ARI condition compared to the Jonswap analytical method. Numerical models generally provide more accurate wave conditions compared to analytical methods since most of wave phenomena are incorporated in the numerical model. Therefore, wave conditions predicted from numerical model have been chosen for this project. Wave conditions estimated for wind from the Northerly direction from Jonswap method, numerical model and chosen wave conditions for 1 year and 250 year extreme wave conditions are presented in Table 6.

**Table 6 Summary of wave conditions at Wyndham ramp**

ARI (years)	Jonswap Method		MIKE21 SW Model		Chosen	
	Significant Wave Height (m)	Peak Wave Period (s)	Significant Wave Height (m)	Peak Wave Period (s)	Significant Wave Height (m)	Peak Wave Period (s)
1	1.3	4.6	1.3	4.3	1.3	4.3
250	3.2	6.3	2.7	5.5	2.7	5.5

Tidal currents, wave induced currents and currents from river flow have been assessed separately. Tidal currents are strong compared to wave induced currents and currents due to river flow. It is recommended to consider combined maximum currents due to tide (2.0 m/s), waves (0.4 m/s) and river flow (0.4 m/s) that is estimated as 2.8 m/s during ebb tide. During the stakeholder consultation, fact finding and lessons learned session conducted on 27 February 2017, it was informed that currents up to 6 knots (3.1m/s) were observed. The present assessment provides approximately similar maximum current speed at Wyndham ramp for ebb tide.

This assessment provides approximate estimates of current conditions at Wyndham ramp based on limited available data. A comprehensive numerical model that includes wind, wave, tidal and river discharge will provide more accurate current predictions at the Wyndham ramp.

## REFERENCES

AS-NZS 1170-2: Structural Design Actions – Part 2: Wind Actions, 2011.

Goda Y. (2000), Random Seas and Design of Maritime Structures, 2<sup>nd</sup> Edition, Advanced Series on Ocean Engineering – Volume 15.

Carter D.J.T. (1982) Prediction of Wave Height and Period for a Constant Wind Velocity using the Jonswap Results. Institute of Oceanographic Sciences, Wormley, Surrey, U.K.

Port of Wyndham, W. Australia, Siltation Study. Hydraulics Research Station. September 1971.

Wolanski et al. (2001) Rapid, Human-Induced Siltation of the Macro Tidal Ord River Estuary, Western Australia. Estuarine, Coastal and Shelf Science. 53, 717-732.





**Advisian**  
WorleyParsons Group

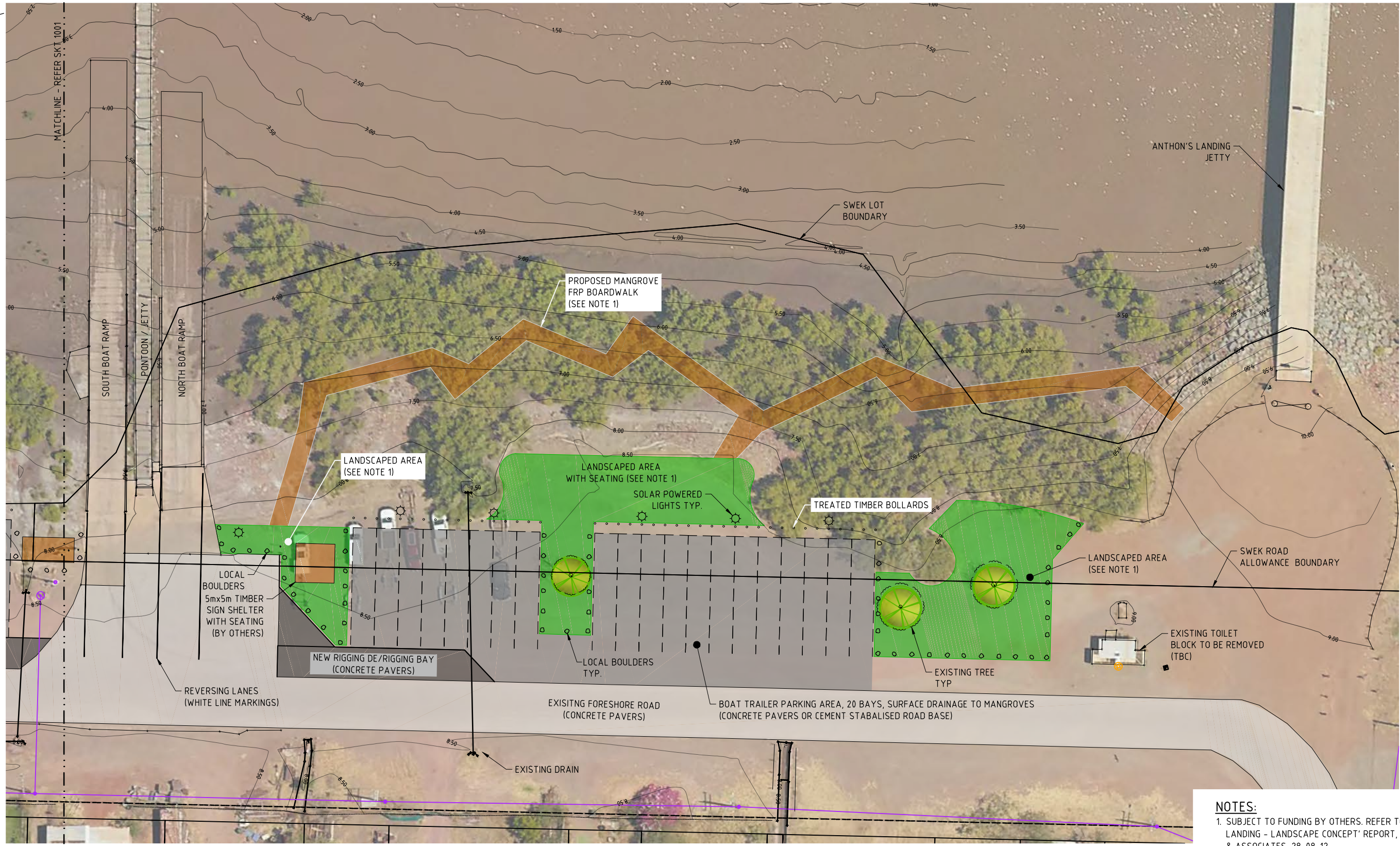
**Shire of Wyndham East Kimberley**  
**Wyndham Boat Launching Facility**  
Planning & Concept Design Report



## **Appendix D    Concept Design Options**

---





PLAN  
SCALE 1:250

INFORMATION ONLY  
NOT TO BE USED  
FOR CONSTRUCTION

**NOTES:**

- SUBJECT TO FUNDING BY OTHERS. REFER TO 'ANTHON'S LANDING - LANDSCAPE CONCEPT' REPORT, BLACKWELL & ASSOCIATES, 28-08-12
- ALL LEVELS ARE IN METRES TO CHART DATUM (m CD)

SCALE OF METRES 1:250

REV	DATE	REVISION DESCRIPTION	DRAWN	DRAFT CHK	DESIGNED	ENG CHK	APPROVED	CUSTOMER	REF DRAWING No	REFERENCE DRAWING TITLE
B	24.03.17	ISSUED FOR CLIENT REVIEW	ST	TJ	CM					
A	15.03.17	ISSUED FOR INTERNAL REVIEW	ST	TJ	CM				301320-14638-MA-SKT-1001	LANDSIDE LAYOUT - SHEET 2 OF 2

A1 SHEET SCALE 1:250

ENGINEERING AND PERMIT STAMPS (As Required)

**Oneway**  
TO SHIP FROM

Copyright ©  
WorleyParsons Services Pty Ltd  
ABN 61 001 279 812

WORLEYPARSONS PROJECT No.  
301012-02153

CUSTOMER

"This drawing is prepared solely for the use of the contractual customer of WorleyParsons and WorleyParsons assumes no liability to any other party for any representations contained in this drawing."

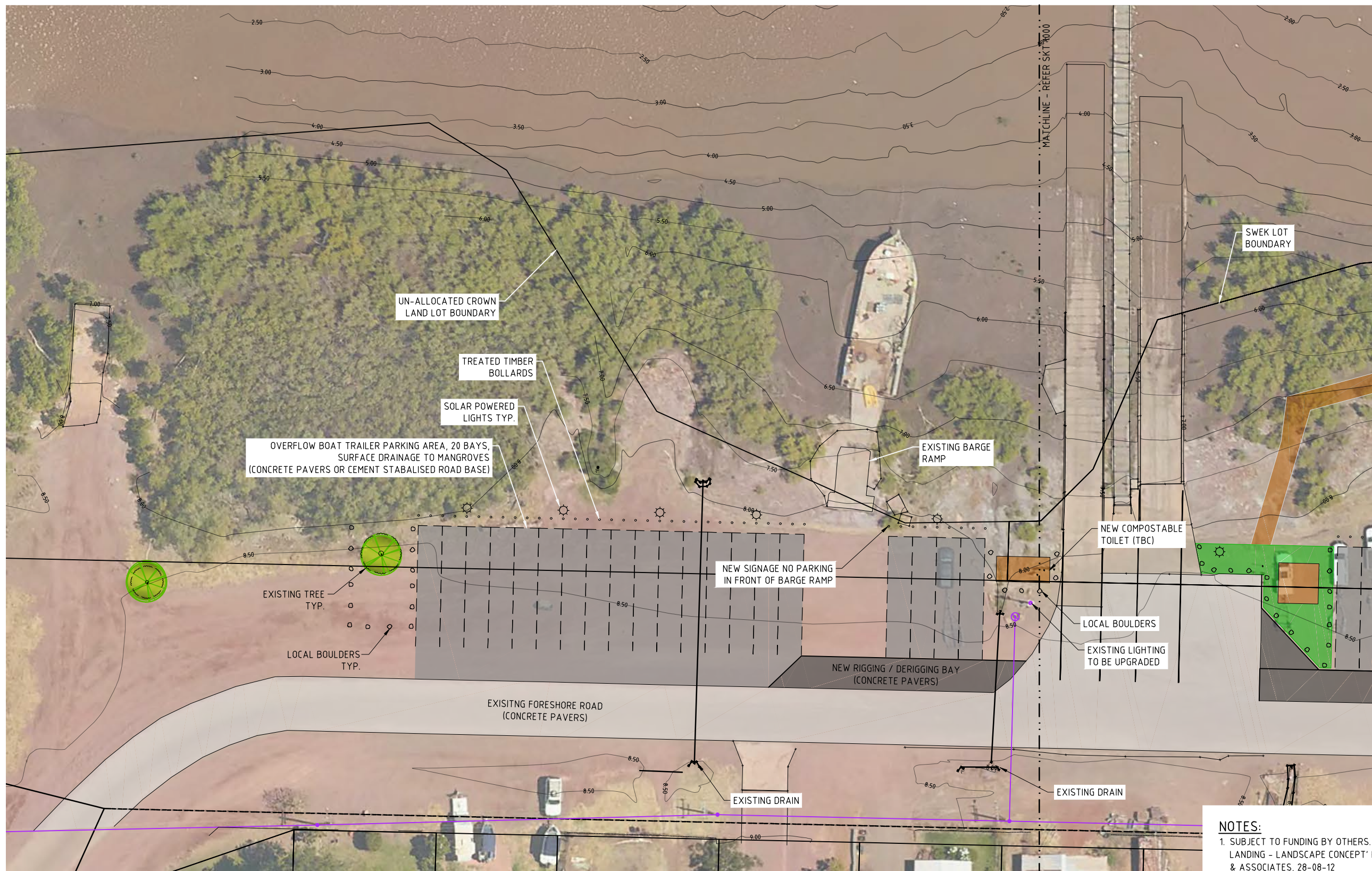
**WorleyParsons**  
resources & energy

SHIRE OF WYNDHAM EAST KIMBERLEY  
WYNDHAM BOAT LAUNCHING FACILITY  
PLANNING & CONCEPT DESIGN  
LANDSIDE LAYOUT - SHEET 1 OF 2

DRG No 301320-14638-MA-SKT-1000

REV B

LOCATION: I:\PROJECTS\301320-14638 SWEK MARINE ENG SERVICES\9\_DRAWINGS\SKT\301320-14638-MA-SKT-1000\_1001.DWG  
 USER NAME: Trevor.james  
 PLOT DATE & TIME: 27/3/2017 8:27:26 AM  
 SAVE DATE & TIME: 27/3/2017 7:38:45 AM  
 WLYP\_A1



PLAN  
SCALE 1:250

INFORMATION ONLY  
NOT TO BE USED  
FOR CONSTRUCTION

**NOTES:**

- SUBJECT TO FUNDING BY OTHERS. REFER TO 'ANTHON'S LANDING - LANDSCAPE CONCEPT' REPORT, BLACKWELL & ASSOCIATES, 28-08-12
- ALL LEVELS ARE IN METRES TO CHART DATUM (m CD)

SCALE OF METRES 1:250

REV	DATE	REVISION DESCRIPTION	DRAWN	DRAFT CHK	DESIGNED	ENG CHK	APPROVED	CUSTOMER	REF DRAWING No	REFERENCE DRAWING TITLE
B	24.03.17	ISSUED FOR CLIENT COMMENT	ST	TJ	CM					
A	15.03.17	ISSUED FOR INTERNAL REVIEW	ST	TJ	CM				301320-14638-MA-SKT-1001	LANDSIDE LAYOUT - SHEET 2 OF 2

A1 SHEET SCALE 1:250

ENGINEERING AND PERMIT STAMPS (As Required)

Copyright ©  
WorleyParsons Services Pty Ltd  
ABN 61 001 279 812

WORLEYPARSONS PROJECT No.  
301012-02153

CUSTOMER

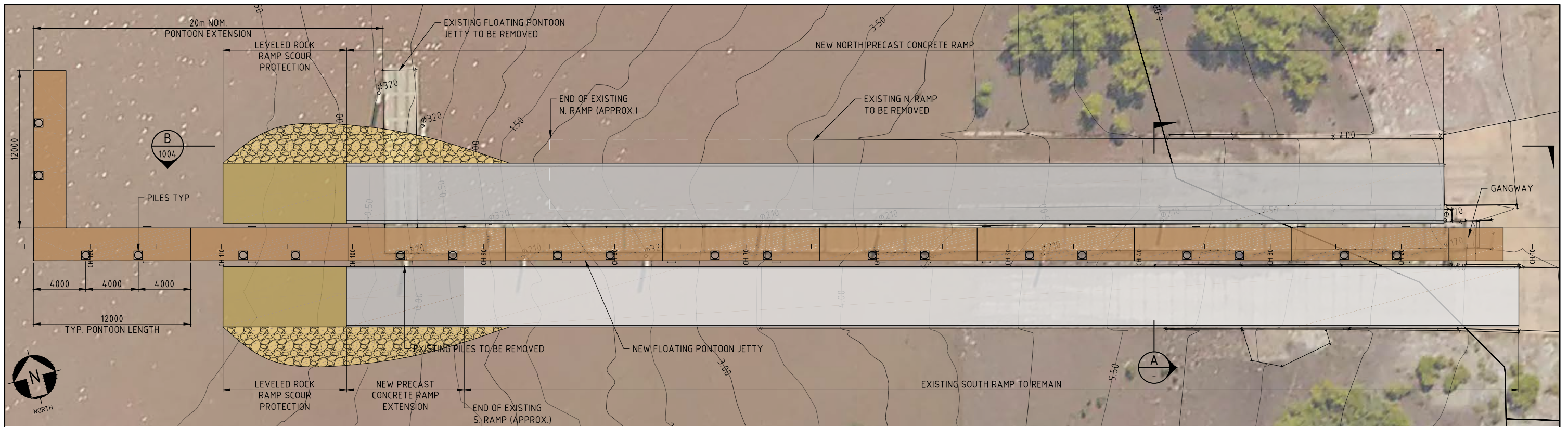
"This drawing is prepared solely for the use of the contractual customer of WorleyParsons and WorleyParsons assumes no liability to any other party for any representations contained in this drawing."

SHIRE OF WYNDHAM EAST KIMBERLEY  
WYNDHAM BOAT LAUNCHING FACILITY  
PLANNING & CONCEPT DESIGN  
LANDSIDE LAYOUT - SHEET 2 OF 2

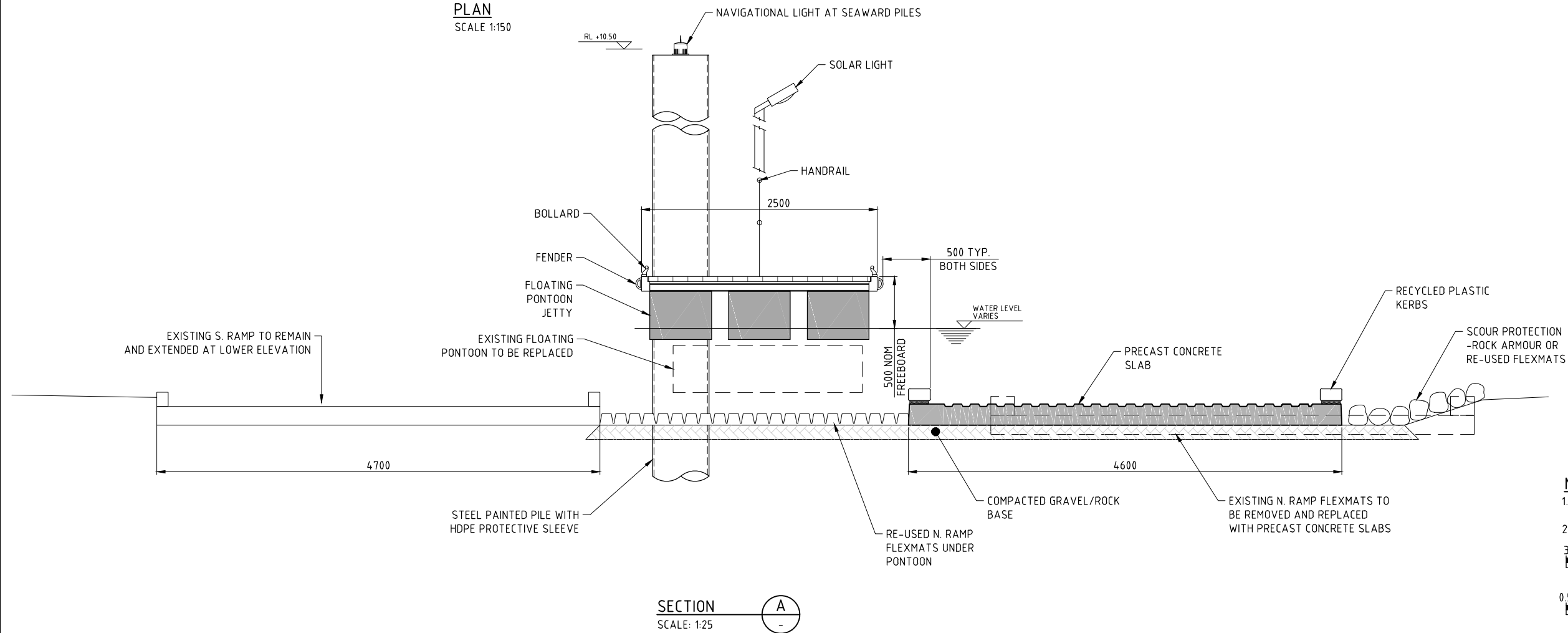
DRG No 301320-14638-MA-SKT-1001

REV B

LOCATION: I:\PROJECTS\301320-14638 SWEK MARINE ENG SERVICES\9\_DRAWINGS\SKT\301320-14638-MA-SKT-1000\_1001.DWG  
 USER NAME: Trevor.james  
 PLOT DATE & TIME: 27/3/2017 8:27:30 AM  
 SAVE DATE & TIME: 27/3/2017 7:38:45 AM  
 WLYP\_A1



**PLAN**  
SCALE 1:150



**SECTION**  
SCALE: 1:25

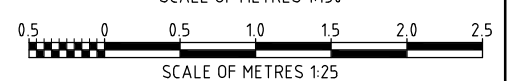
WYNDHAM TIDE LEVELS CHART	
AUST. HEIGHT DATUM (AHD)	CHART DATUM (CD)
4.26m	8.70m HAT
3.33m	7.77m MHS
-1.56m	6.00m MHW
0.00m	4.44m
-1.51m	2.93m MLWN
-3.26m	1.18m MLWS
-4.44m	0.00m
-4.45m	-0.01m LAT

ALL TIDE LEVELS SOURCED FROM WA DEPARTMENT OF TRANSPORT 2010

**INFORMATION ONLY  
NOT TO BE USED  
FOR CONSTRUCTION**

**NOTES:**

- ALL DIMENSIONS ARE IN MILLIMETERS U.N.O.
- ALL LEVELS ARE IN METRES TO CHART DATUM (m CD)



REV	DATE	REVISION DESCRIPTION	DRAWN	DRAFT CHK	DESIGNED	ENG CHK	APPROVED	CUSTOMER	REF DRAWING No	REFERENCE DRAWING TITLE
C	24.05.17	RE-ISSUED FOR CLIENT REVIEW	ST	TJ	CM					
B	24.03.17	ISSUED FOR CLIENT REVIEW	ST	TJ	CM					
A	15.03.17	ISSUED FOR INTERNAL REVIEW	ST	TJ	CM					

A1 SHEET SCALE AS SHOWN

ENGINEERING AND PERMIT STAMPS (As Required)

**Oneway**  
to zero harm

Copyright ©  
WorleyParsons Services Pty Ltd  
ABN 61 001 279 812

WORLEYPARSONS PROJECT No.  
**301012-02153**

CUSTOMER

"This drawing is prepared solely for the use of the contractual customer of WorleyParsons and WorleyParsons assumes no liability to any other party for any representations contained in this drawing."

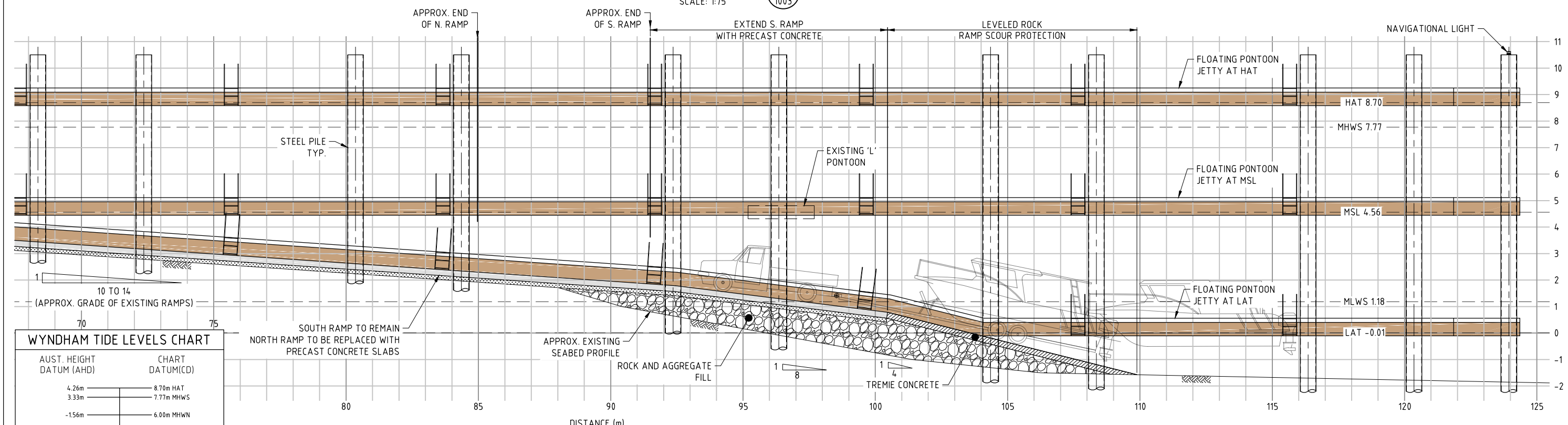
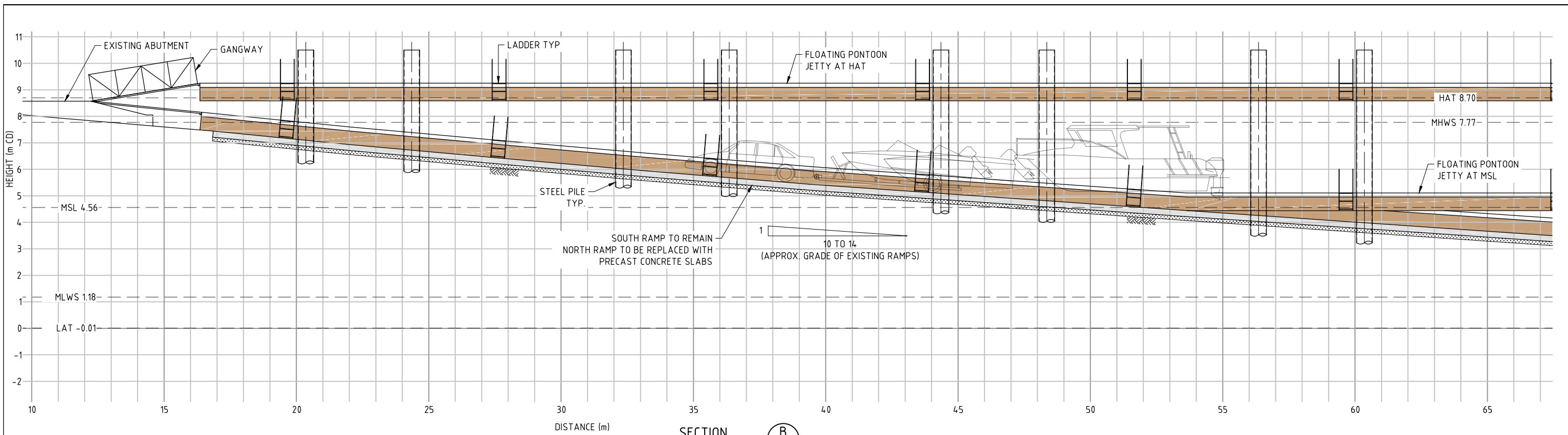
**WorleyParsons**  
resources & energy

SHIRE OF WYNDHAM EAST KIMBERLEY  
WYNDHAM BOAT LAUNCHING FACILITY  
PLANNING & CONCEPT DESIGN  
FLOATING PONTON JETTY OPTION - PLAN AND SECTION

DRG No  
**301012-02153-MA-DRG-1003**

REV  
**C**

LOCATION: I:\PROJECTS\301012-14638 SWEK MARINE ENG SERVICES\9\_DRAWINGS\SKT\301012-14638-MA-SKT-1003-1004.DWG  
USER NAME: sam.lebbutt  
PLOT DATE & TIME: 24/5/2017 2:08:42 PM  
SAVE DATE & TIME: 24/5/2017 1:35:49 PM  
WLYP\_A1



**WYNDHAM TIDE LEVELS CHART**

AUST. HEIGHT DATUM (AHD)	CHART DATUM (CD)
4.26m	8.70m HAT
3.33m	7.77m MHWS
-1.56m	6.00m MHWN
0.00m	4.44m
-1.51m	2.93m MLWN
-3.26m	1.18m MLWS
-4.44m	0.00m
-4.45m	-0.01m LAT

ALL TIDE LEVELS SOURCED FROM WA DEPARTMENT OF TRANSPORT 2010

INFORMATION ONLY  
NOT TO BE USED  
FOR CONSTRUCTION

**NOTES:**

- ALL DIMENSIONS ARE IN MILLIMETERS U.N.O.
- ALL LEVELS ARE IN METRES TO CHART DATUM (m CD)

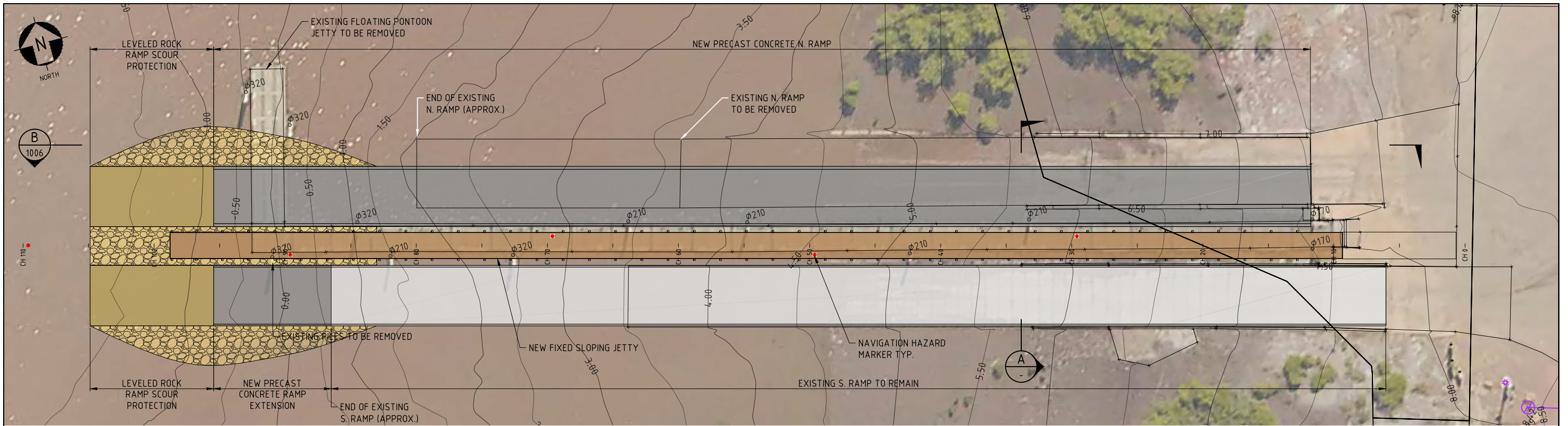
SCALE OF METRES 1:75

REV	DATE	REVISION DESCRIPTION	DRAWN	DRAFT CHK	DESIGNED	ENG CHK	APPROVED	CUSTOMER	REF DRAWING No	REFERENCE DRAWING TITLE
B	24.03.17	ISSUED FOR CLIENT REVIEW	ST	TJ	CM					
A	15.03.17	ISSUED FOR INTERNAL REVIEW	ST	TJ	CM					

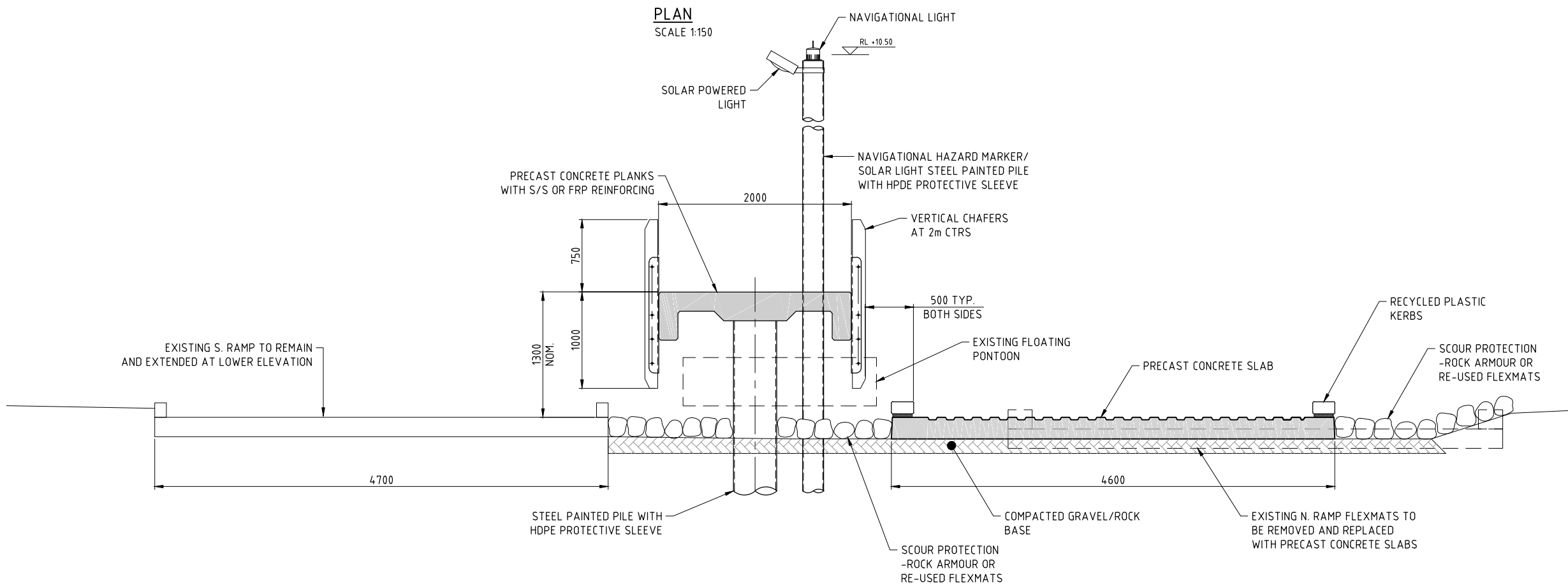
A1 SHEET SCALE 1:75	ENGINEERING AND PERMIT STAMPS (As Required)	CUSTOMER
<p>Copyright © WorleyParsons Services Pty Ltd ABN 61 001 279 812</p>	<p>SHIRE OF WYNDHAM EAST KIMBERLEY WYNDHAM BOAT LAUNCHING FACILITY PLANNING &amp; CONCEPT DESIGN FLOATING PONTOON JETTY OPTION - ELEVATION</p>	<p>DRG No 301320-14638-MA-SKT-1004</p>
<p>WORLDWIDE PROJECT No. 301012-02153</p>		<p>REV B</p>

\*This drawing is prepared solely for the use of the contractual customer of WorleyParsons and WorleyParsons assumes no liability to any other party for any representations contained in this drawing.\*

LOCATION: I:\PROJECTS\301320-14638-SWEEK MARINE ENG SERVICES\9\_DRAWINGS\SKT\301320-14638-MA-SKT-1003-1004.DWG  
USER NAME: Trevor James  
PLOT DATE & TIME: 27/3/2017 8:27:40 AM  
SAVE DATE & TIME: 27/3/2017 8:15:58 AM  
WLYP\_A1



PLAN  
SCALE 1:150



SECTION  
SCALE 1:25

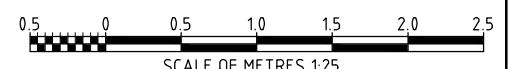
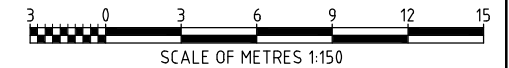
WYNDHAM TIDE LEVELS CHART	
AUST. HEIGHT DATUM (AHD)	CHART DATUM (CD)
4.26m	8.70m HAT
3.33m	7.77m MHWS
-1.56m	6.00m MHWN
0.00m	4.44m
-1.51m	2.93m MLWN
-3.26m	1.18m MLWS
-4.44m	0.00m
-4.45m	-0.01m LAT

ALL TIDE LEVELS SOURCED FROM WA DEPARTMENT OF TRANSPORT 2010

**INFORMATION ONLY  
NOT TO BE USED  
FOR CONSTRUCTION**

NOTES:

- ALL DIMENSIONS ARE IN MILLIMETERS U.N.O.
- ALL LEVELS ARE IN METRES TO CHART DATUM (m CD)



REV	DATE	REVISION DESCRIPTION	DRAWN	DRAFT	CHK	DESIGNED	ENG	CHK	APPROVED	CUSTOMER	REF DRAWING No	REFERENCE DRAWING TITLE
C	24.05.17	RE-ISSUED FOR CLIENT REVIEW	ST	TJ	CM							
B	24.03.17	ISSUED FOR CLIENT REVIEW	ST	TJ	CM							
A	15.03.17	ISSUED FOR INTERNAL REVIEW	ST	TJ	CM							

A1 SHEET SCALE AS SHOWN

ENGINEERING AND PERMIT STAMPS (As Required)

**Oneway**  
TO ZERO HARM

Copyright ©  
WorleyParsons Services Pty Ltd  
ABN 61 001 279 812

WORLEYPARSONS PROJECT No.  
301012-02153

CUSTOMER

"This drawing is prepared solely for the use of the contractual customer of WorleyParsons and WorleyParsons assumes no liability to any other party for any representations contained in this drawing."

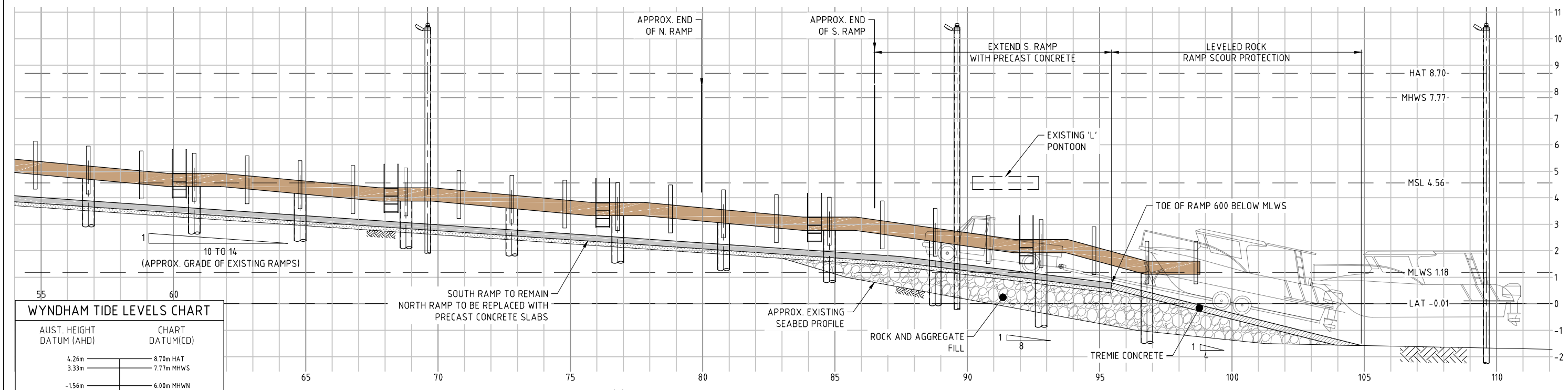
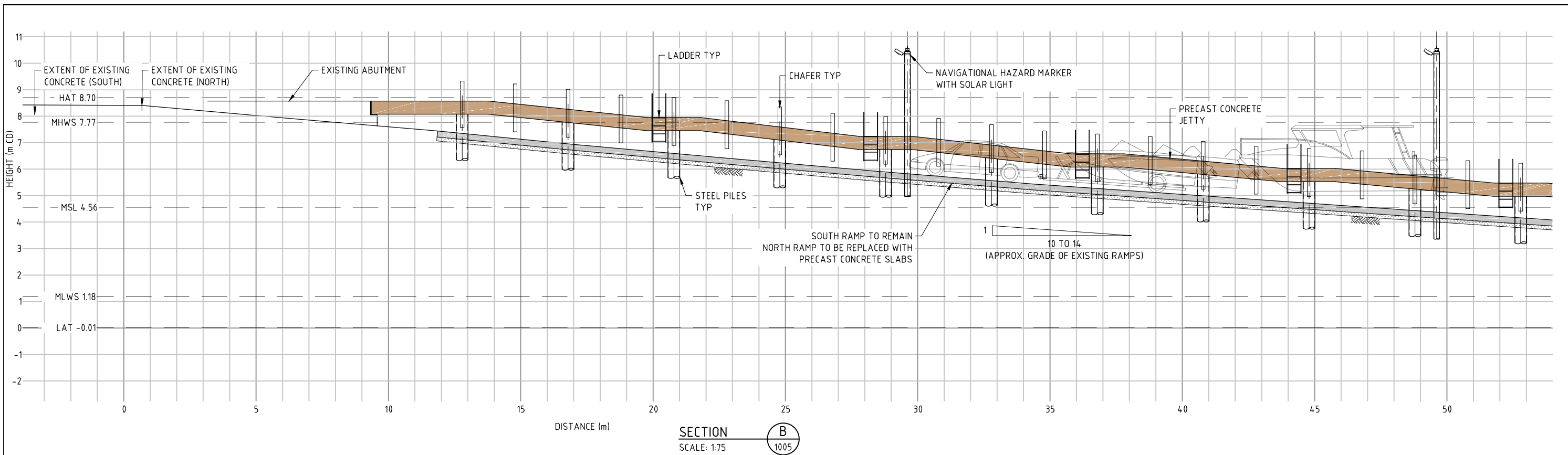
**WorleyParsons**  
resources & energy

SHIRE OF WYNDHAM EAST KIMBERLEY  
WYNDHAM BOAT LAUNCHING FACILITY  
PLANNING & CONCEPT DESIGN  
FIXED JETTY OPTION - PLAN AND SECTIONS

DRG No  
301012-02153-MA-DRG-1005

REV  
C

LOCATION: I:\PROJECTS\301012-14638 SWEK MARINE ENG SERVICES\1 DRAWINGS\SKT\301012-14638-MA-SKT-1005-1006.DWG  
USER NAME: sam.lebbutt  
PLOT DATE & TIME: 24/05/2017 2:05:10 PM  
SAVE DATE & TIME: 24/05/2017 1:38:14 PM  
WLYP\_A1



**WYNDHAM TIDE LEVELS CHART**

AUST. HEIGHT DATUM (AHD)	CHART DATUM (CD)
4.26m	8.70m HAT
3.33m	7.77m MHWS
-1.56m	6.00m MHWN
0.00m	4.44m
-1.51m	2.93m MLWN
-3.26m	1.18m MLWS
-4.44m	0.00m
-4.45m	-0.01m LAT

ALL TIDE LEVELS SOURCED FROM WA DEPARTMENT OF TRANSPORT 2010

INFORMATION ONLY  
NOT TO BE USED  
FOR CONSTRUCTION

**NOTES:**

- ALL DIMENSIONS ARE IN MILLIMETERS U.N.O.
- ALL LEVELS ARE IN METRES TO CHART DATUM (m CD)

SCALE OF METRES 1:75

REV	DATE	REVISION DESCRIPTION	DRAWN	DRAFT CHK	DESIGNED	ENG CHK	APPROVED	CUSTOMER	REF DRAWING No	REFERENCE DRAWING TITLE
B	24.03.17	ISSUED FOR CLIENT REVIEW	ST	TJ	CM					
A	15.03.17	ISSUED FOR INTERNAL REVIEW	ST	TJ	CM					

A1 SHEET SCALE 1:75

ENGINEERING AND PERMIT STAMPS (As Required)

CUSTOMER

**Oneway**  
to zero harm

Copyright ©  
WorleyParsons Services Pty Ltd  
ABN 61 001 279 812

WORLEYPARSONS PROJECT No.  
**301012-02153**

SHIRE OF WYNDHAM EAST KIMBERLEY  
WYNDHAM BOAT LAUNCHING FACILITY  
PLANNING & CONCEPT DESIGN  
FIXED JETTY OPTION - ELEVATION

DRG No  
**301320-14638-MA-SKT-1006**

REV  
**B**

\*This drawing is prepared solely for the use of the contractual customer of WorleyParsons and WorleyParsons assumes no liability to any other party for any representations contained in this drawing.\*

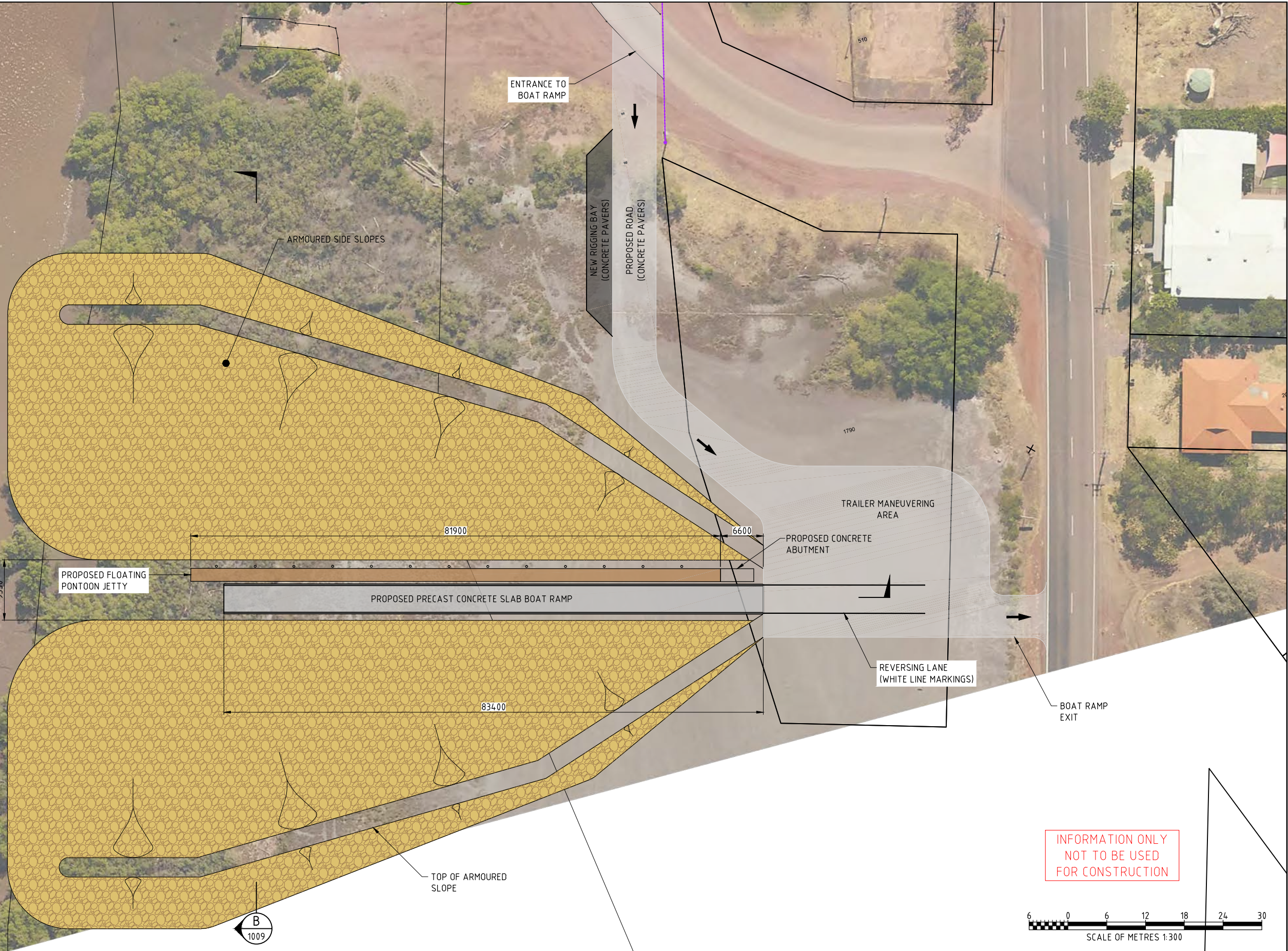
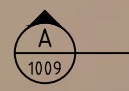
**WorleyParsons**  
PLANNING & CONCEPT DESIGN

SHIRE OF WYNDHAM EAST KIMBERLEY  
WYNDHAM BOAT LAUNCHING FACILITY  
PLANNING & CONCEPT DESIGN  
FIXED JETTY OPTION - ELEVATION

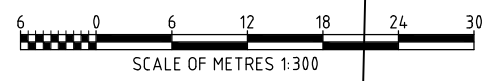
DRG No  
**301320-14638-MA-SKT-1006**

REV  
**B**

LOCATION: I:\PROJECTS\301320-14638-SWEEK MARINE ENG SERVICES\9\_DRAWINGS\SKT\301320-14638-MA-SKT-1005-1006.DWG  
USER NAME: Trevor James  
PLOT DATE & TIME: 27/3/2017 8:27:12 AM  
SAVE DATE & TIME: 27/3/2017 8:26:24 AM  
WLYP\_A1



INFORMATION ONLY  
NOT TO BE USED  
FOR CONSTRUCTION



REV	DATE	REVISION DESCRIPTION	DRAWN	DRAFT CHK	DESIGNED	ENG CHK	APPROVED	CUSTOMER	REF DRAWING No	REFERENCE DRAWING TITLE
B	24.03.17	ISSUED FOR CLIENT REVIEW	ST	TJ	CM					
A	15.03.17	ISSUED FOR INTERNAL REVIEW	ST	TJ	CM					

A1 SHEET SCALE 1:300

ENGINEERING AND PERMIT STAMPS (As Required)

**Oneway**  
SO MUCH MORE

Copyright ©  
WorleyParsons Services Pty Ltd  
ABN 61 001 279 812

WORLEYPARSONS PROJECT No.  
**301012-02153**

CUSTOMER

\*This drawing is prepared solely for the use of the contractual customer of WorleyParsons and WorleyParsons assumes no liability to any other party for any representations contained in this drawing.\*

**WorleyParsons**  
resources & energy

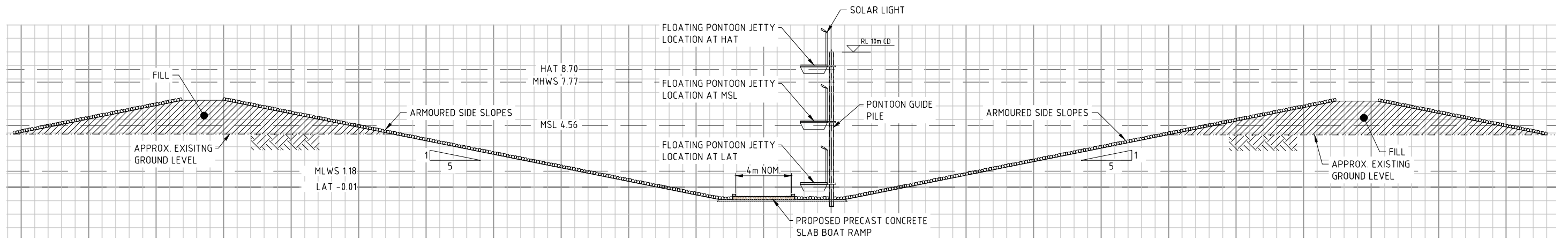
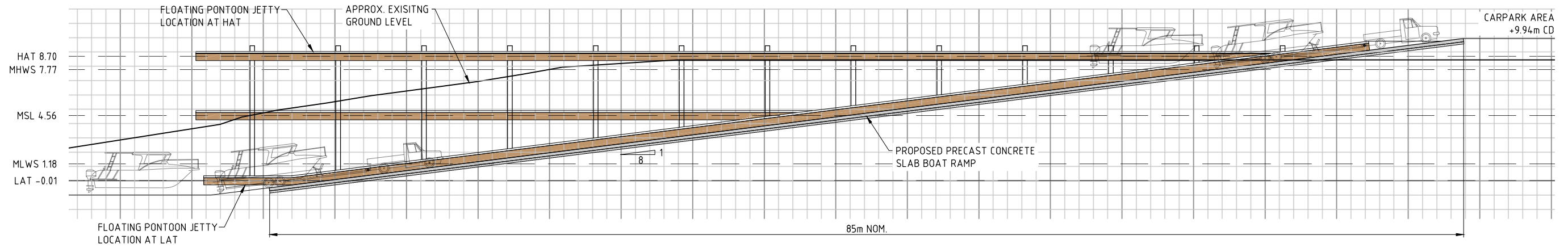
SHIRE OF WYNDHAM EAST KIMBERLEY  
WYNDHAM BOAT LAUNCHING FACILITY  
PLANNING & CONCEPT DESIGN  
INLAND OPTION 1 - LAYOUT

DRG No  
**301320-14638-MA-SKT-1008**

REV  
**B**

LOCATION: I:\PROJECTS\301320-14638 SWEK MARINE ENG SERVICES\9\_DRAWINGS\SKT\301320-14638-MA-SKT-1008.DWG  
USER NAME: Trevor.james  
PLOT DATE & TIME: 27/3/2017 8:27:52 AM  
SAVE DATE & TIME: 27/3/2017 7:43:21 AM  
WLYP\_A1





**WYNDHAM TIDE LEVELS CHART**

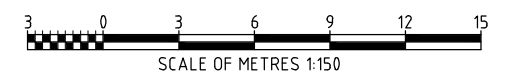
AUST. HEIGHT DATUM (AHD)	CHART DATUM (CD)
4.26m	8.70m HAT
3.33m	7.77m MHWS
-1.56m	6.00m MHW
0.00m	4.44m
-1.51m	2.93m MLWN
-3.26m	1.18m MLWS
-4.44m	0.00m
-4.45m	-0.01m LAT

ALL TIDE LEVELS SOURCED FROM WA DEPARTMENT OF TRANSPORT 2010

INFORMATION ONLY  
NOT TO BE USED  
FOR CONSTRUCTION

**NOTES:**

- ALL DIMENSIONS ARE IN MILLIMETERS U.N.O.
- ALL LEVELS ARE IN METRES TO CHART DATUM (m CD)



REV	DATE	REVISION DESCRIPTION	DRAWN	DRAFT CHK	DESIGNED	ENG CHK	APPROVED	CUSTOMER	REF DRAWING No	REFERENCE DRAWING TITLE
B	24.03.17	ISSUED FOR CLIENT REVIEW	ST	TJ	CM					
A	15.03.17	ISSUED FOR INTERNAL REVIEW	ST	TJ	CM					

A1 SHEET SCALE 1:150

ENGINEERING AND PERMIT STAMPS (As Required)

**Oneway**  
SO MUCH BETTER

Copyright ©  
WorleyParsons Services Pty Ltd  
ABN 61 001 279 812

WORLEYPARSONS PROJECT No.  
**301012-02153**

CUSTOMER

"This drawing is prepared solely for the use of the contractual customer of WorleyParsons and WorleyParsons assumes no liability to any other party for any representations contained in this drawing."

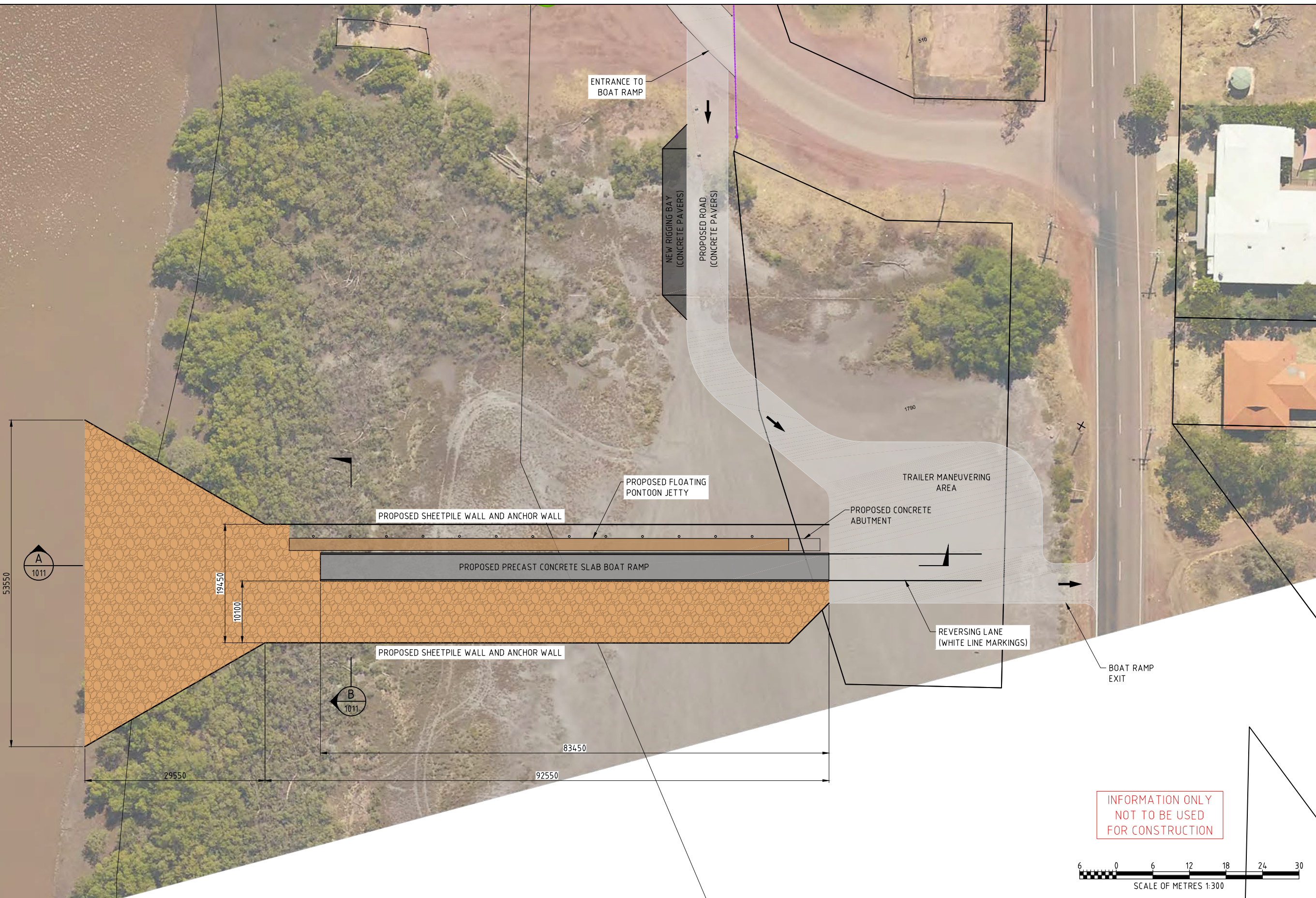
**WorleyParsons**  
resources & energy

SHIRE OF WYNDHAM EAST KIMBERLEY  
WYNDHAM BOAT LAUNCHING FACILITY  
PLANNING & CONCEPT DESIGN  
INLAND OPTION1 - SECTIONS

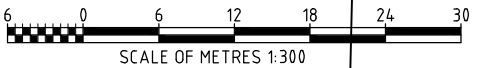
DRG No  
**301320-14638-MA-SKT-1009**

REV  
**B**

LOCATION: I:\PROJECTS\301320-14638 SWEK MARINE ENG SERVICES\9\_DRAWINGS\SKT\301320-14638-MA-SKT-1009.DWG  
USER NAME: Trevor.james  
PLOT DATE & TIME: 27/3/2017 8:27:56 AM  
SAVE DATE & TIME: 27/3/2017 7:50:38 AM  
WLYP\_A1



INFORMATION ONLY  
NOT TO BE USED  
FOR CONSTRUCTION



REV	DATE	REVISION DESCRIPTION	DRAWN	DRAFT CHK	DESIGNED	ENG CHK	APPROVED	CUSTOMER	REF DRAWING No	REFERENCE DRAWING TITLE
B	24.03.17	ISSUED FOR CLIENT REVIEW	ST	TJ	CM					
A	15.03.17	ISSUED FOR INTERNAL REVIEW	ST	TJ	CM					

A1 SHEET SCALE 1:300

ENGINEERING AND PERMIT STAMPS (As Required)

**Oneway**  
so much more

Copyright ©  
WorleyParsons Services Pty Ltd  
ABN 61 001 279 812

WORLEYPARSONS PROJECT No.  
**301012-02153**

CUSTOMER

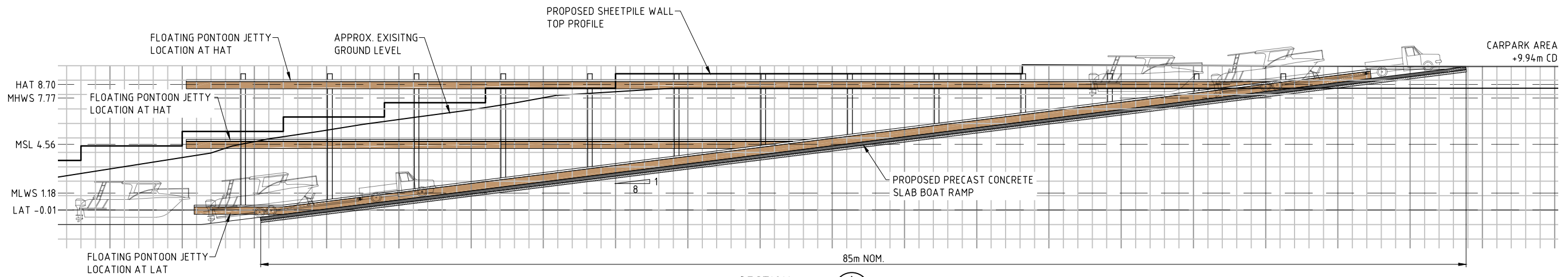
\*This drawing is prepared solely for the use of the contractual customer of WorleyParsons and WorleyParsons assumes no liability to any other party for any representations contained in this drawing.\*

**WorleyParsons**  
resources & energy

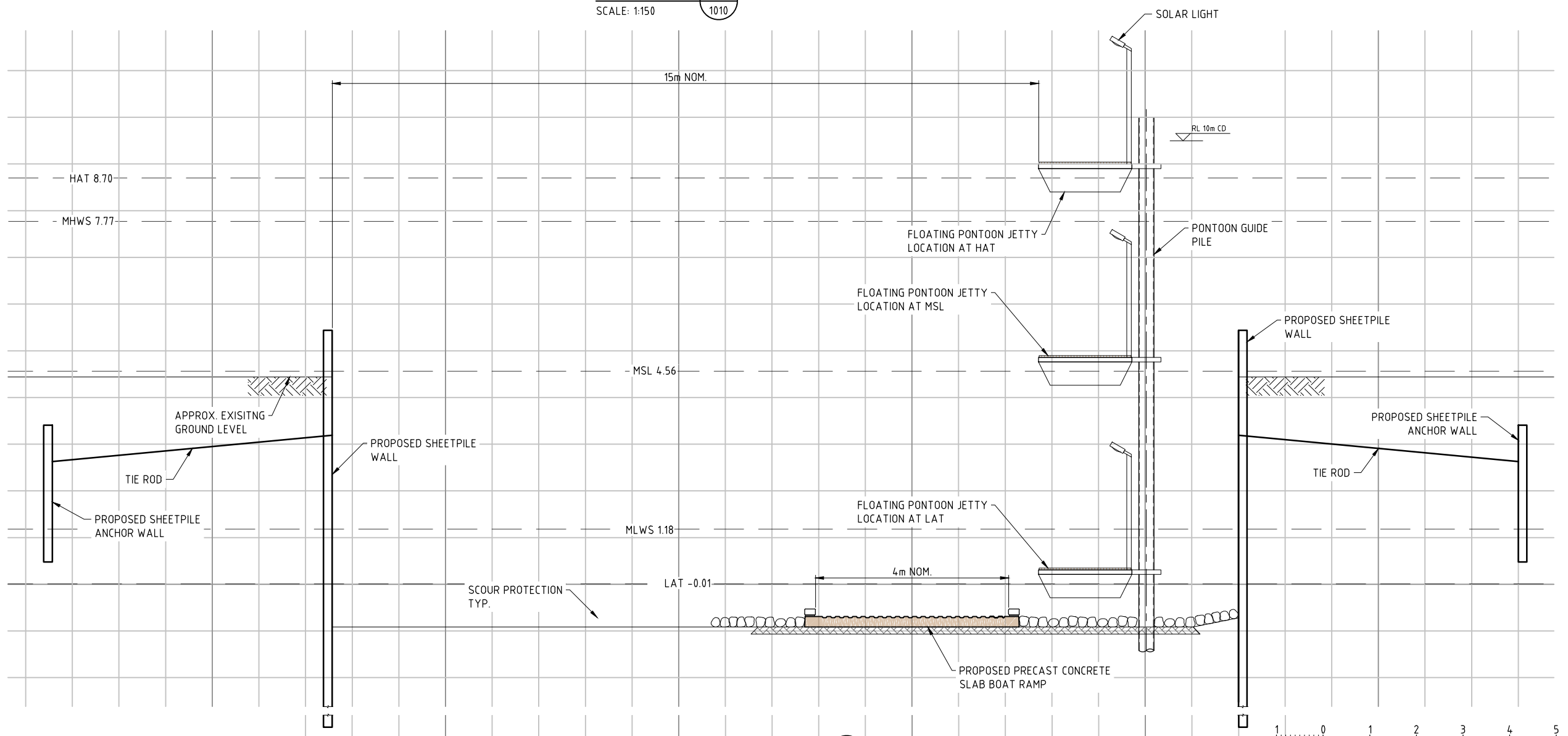
SHIRE OF WYNDHAM EAST KIMBERLEY  
WYNDHAM BOAT LAUNCHING FACILITY  
PLANNING & CONCEPT DESIGN  
INLAND SHEETPILE OPTION 2 - LAYOUT

DRG No **301320-14638-MA-SKT-1010** REV **B**

LOCATION: I:\PROJECTS\301320-14638 SWEK MARINE ENG SERVICES\9\_DRAWINGS\SKT\301320-14638-MA-SKT-1010.DWG  
 USER NAME: Trevor James  
 PLOT DATE & TIME: 27/3/2017 8:28:03 AM  
 SAVE DATE & TIME: 27/3/2017 7:54:59 AM  
 WLYP\_A1

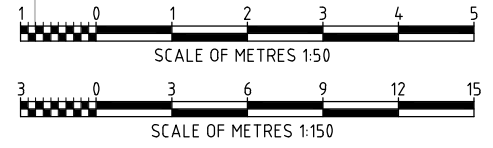


SECTION A  
SCALE: 1:150



SECTION B  
SCALE: 1:50

- NOTES:
1. ALL DIMENSIONS ARE IN MILLIMETERS U.N.O.
  2. ALL LEVELS ARE IN METRES TO CHART DATUM (m CD)



WYNDHAM TIDE LEVELS CHART

AUST. HEIGHT DATUM (AHD)	CHART DATUM (CD)
4.26m	8.70m HAT
3.33m	7.77m MHWS
-1.56m	6.00m MHWN
0.00m	4.44m
-1.51m	2.93m MLWN
-3.26m	1.18m MLWS
-4.44m	0.00m
-4.45m	-0.01m LAT

INFORMATION ONLY  
NOT TO BE USED  
FOR CONSTRUCTION

ALL TIDE LEVELS SOURCED FROM WA DEPARTMENT OF TRANSPORT 2010

REV	DATE	REVISION DESCRIPTION	DRAWN	DRAFT CHK	DESIGNED	ENG CHK	APPROVED	CUSTOMER	REF DRAWING No	REFERENCE DRAWING TITLE
B	24.03.17	ISSUED FOR CLIENT REVIEW	ST	TJ	CM					
A	15.03.17	ISSUED FOR INTERNAL REVIEW	ST	TJ	CM					

A1 SHEET SCALE AS SHOWN

**Oneway**  
so much more

Copyright ©  
WorleyParsons Services Pty Ltd  
ABN 61 001 279 812

WORLEYPARSONS PROJECT No.  
301012-02153

ENGINEERING AND PERMIT STAMPS (As Required)

CUSTOMER

SHIRE OF WYNDHAM EAST KIMBERLEY

WYNDHAM BOAT LAUNCHING FACILITY  
PLANNING & CONCEPT DESIGN  
INLAND SHEETPILE OPTION 2 - SECTIONS

DRG No 301320-14638-MA-SKT-1011

REV B

**WorleyParsons**  
resources & energy

SHIRE OF WYNDHAM EAST KIMBERLEY  
WYNDHAM BOAT LAUNCHING FACILITY  
PLANNING & CONCEPT DESIGN  
INLAND SHEETPILE OPTION 2 - SECTIONS

DRG No 301320-14638-MA-SKT-1011

REV B

LOCATION: I:\PROJECTS\301320-14638 SWEK MARINE ENG SERVICES\10 DRAWINGS\SKT\301320-14638-MA-SKT-1011.DWG  
USER NAME: Trevor James  
PLOT DATE & TIME: 27/3/2017 8:27:16 AM  
SAVE DATE & TIME: 27/3/2017 8:26:18 AM  
WLYP\_A1



## **Appendix E Stakeholder Consultations – Concept Options**

---





## **E1**

### **SWEK Stakeholder Advisory Group Meeting (27 March 17) Notes and Minutes**

Chris Meisl (Advisian - Senior Marine Structural Engineer) and Mark Davidson (SWEK – Manager Engineering Services) attended the SWEK Stakeholder Advisory Group (SAG) Meeting in Wyndham on 27 March 2017. The purpose of the meeting was to present the background to the project, issues experienced by current facility users and to present the boat ramp facility concept options. Refer to Appendix A for minutes from the meetings. Key points raised by stakeholders were as follows:

- Floating pontoon option:
  - Looked upon favourably. Feedback that the existing pontoon has generally worked well and suited its purpose.
- Fixed jetty structure:
  - Would be more difficult for boat users to access compared to a pontoon structure. Potential for vessels to become damaged if not berthing against structure in a safe manner.
  - Crocodiles would climb onto the jetty, as they do the ramp. They generally do not climb on the pontoon.
  - Potential for the deck to have sediment build-up due to suspended sediments in water, and become a slipping hazard. Post meeting note, this could be minimised by having an open deck / mesh deck.
- Inland harbour options:
  - Concerns regarding sedimentation were raised. Was discussed that there would be potential for sedimentation and this would need to be studied during the detailed design phase. Maintenance dredging would most likely be required in these options.
  - Locations would have in excess of 20m of soft marine sediments. Was discussed that ground improvements may be required.
  - Cost may be prohibitive.
- Queries as to how this project fits into the overall Shire infrastructure program.
- Queries regarding potential funding sources.
- Discussion regarding going out for public comment, and managing the residents expectations vs. Shire's budget.



**Advisian**

WorleyParsons Group

**Shire of Wyndham East Kimberley  
Wyndham Boat Launching Facility**  
Planning & Concept Design Report



**E2**

**Questionnaire – Public Feedback on Existing Facility and Concept Options**



## Questionnaire

Have your say about the proposed Wyndham Boat Launching Facility design layout options.

Rank your preferred Wyndham Boat Launching Facility design lay out option in order:

	Rank 1 - 4
Floating Pontoon Concept Option	
Fixed Jetty Concept Option	
Inland Concept Option – Alternative 1	
Inland Concept Option – Alternative 2	

	Yes	No
Do you agree with the Landside and Parking Area Concept?		
Have you ever launched a boat or vessel at the Wyndham Boat Ramp?		

If yes, what type of boat or vessel did you launch?

	Tick
Power boat	
Canoe or kayak	
Small unpowered boat / vessel	
Other	
Sail Boat	

	Times Per Week	Times Per Month	Times Per Year	Never
How often do you use the boat ramp?				
	Yes		No	
Do you have difficulties launching or retrieving your boat?			Comments in 'other comment' below	
	Yes		No	
Do you consider the facilities adequate?				
Is the turnaround at the top of the ramp adequate?				
Is there sufficient area for rigging and derigging?				

	Yes	No	
Do you experience delays when you use the facilities?			Comments in 'other comment' below
What size equipment do you use at the facility?	Boat Size	Trailer Axle/s	Vehicle Type

	Yes	No
Would you like ablution facilities located at the boat ramp?		
Would you like Anthon Landing ablution facilities to be retained?		

Do you have any suggestions to improve the Landside and Parking Area or Boat Ramp Options?

.....

.....

.....

.....

Do you have any other comments?

.....

.....

.....

.....

Date:        /        /

**THANK YOU FOR YOUR PARTICIPATION**





**Advisian**  
WorleyParsons Group

**Shire of Wyndham East Kimberley**  
**Wyndham Boat Launching Facility**  
Planning & Concept Design Report



## **Appendix F    ± 40% CAPEX Estimate**

---





**Advisian**

WorleyParsons Group

### COST ESTIMATE +/- 40%

#### Wyndham Boat Ramp Concept Design

#### Concept Option Summary

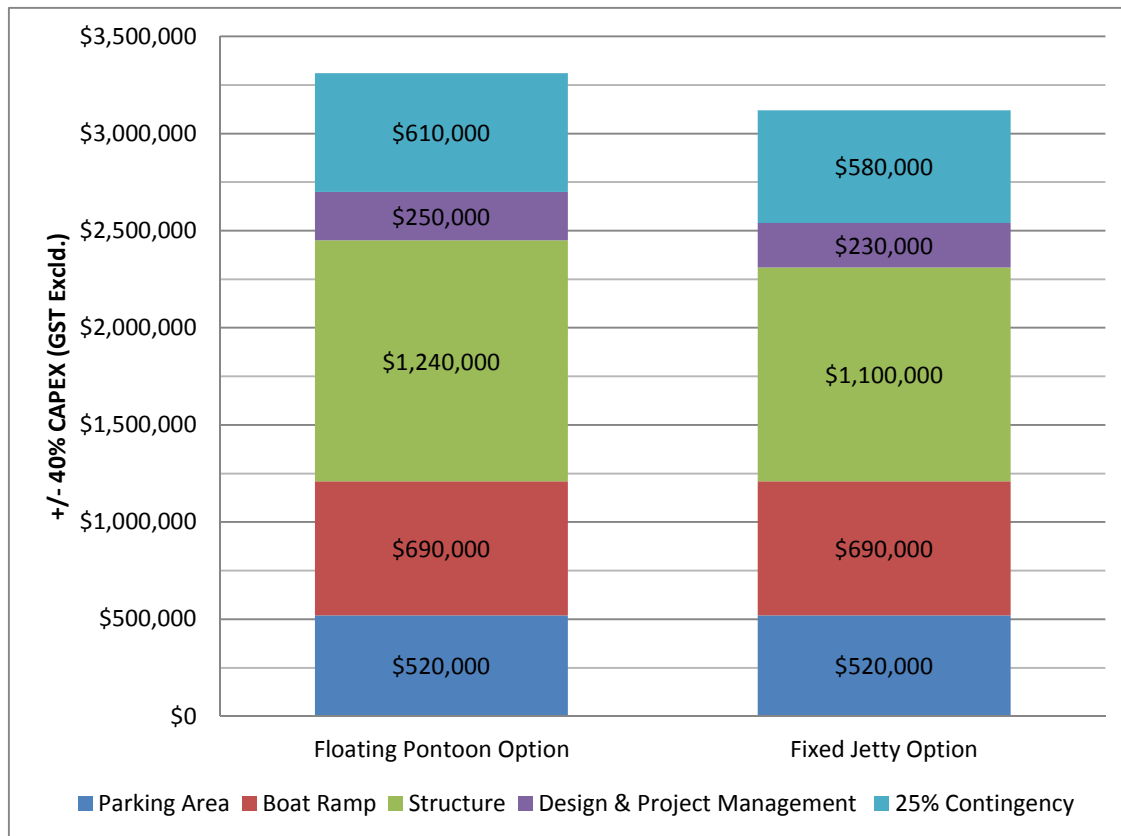
301320-14638

Revision: 0

Date:

May-17

Item	Concept Option	
	Floating Pontoon Option	Fixed Jetty Option
Parking Area	\$520,000	\$520,000
Boat Ramp	\$690,000	\$690,000
Structure	\$1,240,000	\$1,100,000
Design & Project Management	\$250,000	\$230,000
25% Contingency	\$610,000	\$580,000
<b>Total</b>	<b>\$3,310,000</b>	<b>\$3,120,000</b>





**Advisian**

WorleyParsons Group

**COST ESTIMATE +/- 40%**

**Wyndham Boat Ramp Concept Design**

**Fixed Jetty Option**

**301320-14638**

**Revision: 0**

**Date: May-17**

Item	Description	Unit	Qty	Rate	Total	Comments / Back-up Information
<b>1.0</b>	<b>Contractor Preliminaries</b>					
1.1	Preliminaries, General Mob-Demob	%	25		\$203,878	% Total (Exclude Barge Mob / Demob)
1.2	Mob/Demob Pile Driving Barge	Item	1	\$80,000	\$80,000	
<b>2.0</b>	<b>Fixed Jetty - 95m Long</b>					
2.1	Supply and delivery tubular piles, including coating	MT	71.6	\$2,500	\$178,877	Purchase in Perth or Darwin, coating applied and transported to site
2.2	Supply and deliver HDPE protective sleeve	m	96	\$250	\$24,000	
2.3	Pitch, splice and install piles	No.	24.0	\$5,500	\$132,000	2/3 piles installed per day - 5 man team
2.4	Install pile sleeves	No.	24.0	\$1,200	\$28,800	
2.5	Supply and delivery tubular piles, including coating - Nav Aids	MT	5.9	\$2,500	\$14,679	Purchase in Perth or Darwin, coating applied and transported to site
2.6	Pitch, splice and install piles - Nav Aids	No.	5.0	\$5,500	\$27,500	2/3 piles installed per day - 5 man team
2.7	Supply and delivery of precast concrete deck units - FRP / SS reo	MT	138.9375	\$1,500	\$208,406	Precast in Perth or Darwin and delivered to Site (2m wide x 0.2m thick, 0.5m downs
2.8	Install precast concrete slabs	No	24	\$3,000	\$72,000	
2.9	Insitu Concrete pour to pile and stainless steel dowel connections	No	24	\$2,000	\$48,000	
2.10	Supply and install chafers	No	85	\$750	\$63,750	
2.11	Supply and install solar lights at every 20m	No.	5.0	\$3,500	\$17,500	
<b>Total Direct Cost</b>					<b>\$1,099,391</b>	
<b>3.0</b>	<b>Design &amp; Project Management</b>	%	12		\$131,927	
<b>4.0</b>	<b>Escalation</b>	%	0		\$0	Excluded
<b>5.0</b>	<b>Contingency</b>	%	25		\$274,848	
<b>Total Indirect Cost</b>					<b>\$406,774</b>	
<b>Total Installed Cost</b>					<b>\$1,506,165</b>	



**Advisian**

WorleyParsons Group

**COST ESTIMATE +/- 40%**

**Wyndham Boat Ramp Concept Design**

**Floating Pontoon Option**

301320-14638

Revision: 0

Date: May-17

Item	Description	Unit	Qty	Rate	Total	Comments / Back-up Information
1.0	<b>Contractor Preliminaries</b>					
	Preliminaries, General Mob-Demob	%	25		\$231,668	% Total (Exclude Barge Mob / Demob)
	Mob/Demob Pile Driving Barge	Item	1	\$80,000	\$80,000	
2.0	<b>Floating Pontoon - 100m long + 12m 'L' Pontoon</b>					
	Supply and delivery tubular piles, including coating	MT	131	\$2,500	\$328,373	Purchase in Perth or Darwin, coating applied and transported to site
	Supply and deliver HDPE protective sleeve	m	228	\$250	\$57,000	
	Pitch, splice and install piles	No.	19	\$5,500	\$104,500	2/3 piles installed per day - 5 man team
	Install pile sleeves	No.	19	\$1,200	\$22,800	
	Supply and install 2.5m wide floating pontoon	m2	280	\$1,300	\$364,000	EWS Indicative quote (24-3-17), plus allowance for stronger sections and location
	Supply and install gangway	Item	1	\$10,000	\$10,000	
	Supply and install solar lights at every 20m	No.	5	\$3,000	\$15,000	
	Supply and install central hand rail	m	100	\$250	\$25,000	
<b>Total Direct Cost</b>					<b>\$1,238,341</b>	
3.0	Design & Project Management	%	12		\$148,601	
4.0	Escalation	%	0		\$0	Excluded
5.0	Contingency	%	25		\$309,585	
<b>Total Indirect Cost</b>					<b>\$458,186</b>	
<b>Total Installed Cost</b>					<b>\$1,696,527</b>	

**Advisian**

WorleyParsons Group

**COST ESTIMATE +/- 40%****Wyndham Boat Ramp Concept Design****Boat Ramps****301320-14638****Revision: 0****Date: May-17**

Item	Description	Unit	Qty	Rate	Total	Comments / Back-up Information
1.0	<b>Contractor Preliminaries</b>					
	Preliminaries, General Mob-Demob	%	25		\$137,142	% Total
2.0	<b>North Boat Ramp - 85m Long (remove and replace)</b>					
	Removal of existing concrete boat ramp (Flex Mat) and place between ramps	Item	1	\$30,000	\$30,000	Remove and re-use as scour protection between N+S Ramp
	Excavate and dispose of unsuitable material	m <sup>3</sup>	200	\$30	\$6,100	allowance
	Supply and install crushed aggregate base	m <sup>3</sup>	76.5	\$80	\$6,120	Assume 150mm thick x 5m Wide, use existing basecourse under ramp
	Compacted rubble base for ramp extension	m <sup>3</sup>	280	\$120	\$33,600	
	Temie Concrete at ramp extension	m <sup>3</sup>	15	\$300	\$4,500	
	Armour stone (100mm / 250mm diameter)	m <sup>3</sup>	50	\$100	\$5,000	2m wide shoulder on side of ramp
	Terrafox 600R Geotextile	m <sup>2</sup>	200	\$15	\$3,000	
	Supply and delivery of precast concrete slabs	MT	219.9375	\$1,300	\$285,919	Precast in Perth or Darwin and delivered to Site (Slabs 4.6x0.225x1.5m)
	Install precast concrete slabs	No	57	\$1,000	\$57,000	
	Supply and install recycled plastic kerbs (230 x 125) and stainless steel HAS rods	m	200	\$180	\$36,000	
3.0	<b>S Boat Ramp - 10m Long Extension of Concrete Ramp</b>					
	Excavate and dispose of unsuitable material	m <sup>3</sup>	20	\$30	\$600	allowance
	Supply and install crushed aggregate base	m <sup>3</sup>	13.5	\$80	\$1,080	Assume 150mm x 5m Wide
	Compacted rubble base for ramp extension	m <sup>3</sup>	255	\$100	\$25,500	
	Temie Concrete at ramp extension	m <sup>3</sup>	15	\$300	\$4,500	
	Armour stone (100mm / 250mm diameter)	m <sup>3</sup>	50	\$100	\$5,000	2m wide shoulder on side of ramp, entire length of ramp
	Terrafox 600R Geotextile	m <sup>2</sup>	200	\$15	\$3,000	
	Supply and delivery of precast concrete slabs	MT	25.875	\$1,200	\$31,050	Precast in Perth or Darwin and delivered to Site (Slabs 4.6x0.225x1.5m)
	Install precast concrete slabs	No	7	\$1,000	\$7,000	
	Supply and install recycled plastic kerbs (230 x 125) and stainless steel HAS rods	m	20	\$180	\$3,600	New kerb on extension
<b>Total Direct Cost</b>					<b>\$685,711</b>	
4.0	Design & Project Management	%	8		\$54,857	
5.0	Escalation	%	0		\$0	Excluded
6.0	Contingency	%	25		\$171,428	
<b>Total Indirect Cost</b>					<b>\$226,285</b>	
<b>Total Installed Cost</b>					<b>\$911,996</b>	



**Advisian**

WorleyParsons Group

**COST ESTIMATE +/- 40%**

**Wyndham Boat Ramp Concept Design  
Landside and Trailer Parking - All Paved  
301320-14638  
Revision: 0**

**Date: May-17**

Item	Description	Unit	Qty	Rate	Total	Comments / Back-up Information
1.0	<b>Contractor Preliminaries</b>					
	Preliminaries, General Mob-Demob	%	20		\$87,090	% Total
2.0	<b>Pavement</b>					
	Bulk Earthworks - cut and dispose	m <sup>3</sup>	1250	\$20	\$25,000	Assume 500mm deep average
	Insitu compaction of subgrade	m <sup>2</sup>	2,500	\$5	\$12,500	Rawlinsons
	Select Fill - 500mm thick - supply and install	m <sup>3</sup>	1,250	\$30	\$37,500	Rawlinsons
	Base Course - 150 - supply and install	m <sup>3</sup>	375	\$50	\$18,750	Denham
	Concrete Brick Pavers - supply and install	m <sup>2</sup>	2,500	\$88	\$220,000	Rawlinsons
	White Line Marking	m	100	\$10	\$1,000	
	Treated Timber Bollards	m	125	\$50	\$6,200	Rawlinsons
3.0	<b>Stormwater Drainage</b>					
	Drainage	Item		Excl'd	\$0	Surface drainage, improvements to existing drainage exld.
4.0	<b>Public Lighting</b>					
	Solar Power Lights including foundations	No	12	\$4,500	\$54,000	
5.0	<b>Miscellaneous</b>					
	New Compostable Toilet	m <sup>2</sup>	10	\$4,800	\$48,000	
	Refurb existing toilet block	Item	1	\$7,500	\$7,500	
	Boat Ramp Signage	Item	1	\$5,000	\$5,000	
	Landscaping, seating, shelter, etc.	Item		Excl'd	\$0	By Others, subject to funding
<b>Total Direct Cost</b>					<b>\$522,540</b>	
3.0	Design & Project Management	%	8		\$41,803	
4.0	Escalation	%	0		\$0	Excluded
5.0	Contingency	%	25		\$130,635	
<b>Total Indirect Cost</b>					<b>\$172,438</b>	
<b>Total Installed Cost</b>					<b>\$694,978</b>	



**Wyndham Boat Ramp Concept Design**  
**Landside and Trailer Parking - Minimal paving near ramp, gravel in parking areas**  
**301320-14638**  
**Revision: 0**

Date: **May-17**

Item	Description	Unit	Qty	Rate	Total	Comments / Back-up Information
1.0	<b>Contractor Preliminaries</b>					
	Preliminaries, General Mob-Demob	%	20		\$43,440	% Total
2.0	<b>Pavement</b>					
	Bulk Earthworks - cut and dispose Rigging Area	m <sup>3</sup>	125	\$20	\$2,500	Assume 500mm deep average
	Insitu compaction of subgrade - Rigging Area	m <sup>2</sup>	250	\$5	\$1,250	Rawlinsons
	Select Fill - 500mm thick - supply and install - Rigging Area	m <sup>3</sup>	125	\$30	\$3,750	Rawlinsons
	Base Course - 150 - supply and install - Rigging Area	m <sup>3</sup>	38	\$50	\$1,875	Rawlinsons
	Concrete Brick Pavers - supply and install - Rigging Area	m <sup>2</sup>	250	\$88	\$22,000	Rawlinsons
	Bulk Earthworks - cut and dispose - Parking Area	m <sup>3</sup>	1125	\$20	\$22,500	Assume 300mm deep average
	Insitu compaction of subgrade - Parking Area	m <sup>2</sup>	2,250	\$5	\$11,250	Rawlinsons
	Select Fill - 200mm thick - supply and install - Parking Area	m <sup>3</sup>	450	\$30	\$13,500	Rawlinsons
	Base Course - 150 - supply and install - Rigging Area	m <sup>3</sup>	337.5	\$50	\$16,875	Rawlinsons
	White Line Marking	m	100	\$10	\$1,000	
	Treated Timber Bollards	m	125	\$50	\$6,200	Rawlinsons
3.0	<b>Stormwater Drainage</b>					
	Drainage	Item		Excl'd	\$0	Surface drainage
4.0	<b>Public Lighting</b>					
	Solar Power Lights including foundations	No	12	\$4,500	\$54,000	
5.0	<b>Miscellaneous</b>					
	Compostable Toilet	m2	10	\$4,800	\$48,000	
	Refurb existing toilet block	Item	1	\$7,500	\$7,500	
	Remove Existing Toilet Block	Item		Excl'd	\$0	Assume remains
	Boat Ramp Signage	Item	1	\$5,000	\$5,000	
	Landscaping, seating, shetler, etc.	Item		Excl'd	\$0	By Others, subject to funding
<b>Total Direct Cost</b>					<b>\$260,640</b>	
3.0	Design & Project Management	%	8		\$20,851	
4.0	Escalation	%	0		\$0	Excluded
5.0	Contingency	%	25		\$65,160	
<b>Total Indirect Cost</b>					<b>\$86,011</b>	
<b>Total Installed Cost</b>					<b>\$346,651</b>	